



Surge protection

Solutions for every application

Interference-free power supply and signal transmission

A constant energy supply and secure data links are of vital importance to the operational reliability of electrical systems, installations and devices.

Phoenix Contact meets all of these requirements with the TRABTECH product line. Coordinated solutions consisting of surge protection, monitoring, device circuit breakers and EMC filters offer consistently high power and signal quality for maximum availability.



Protective devices for limiting high-energy surge voltages and high-frequency interference voltages.

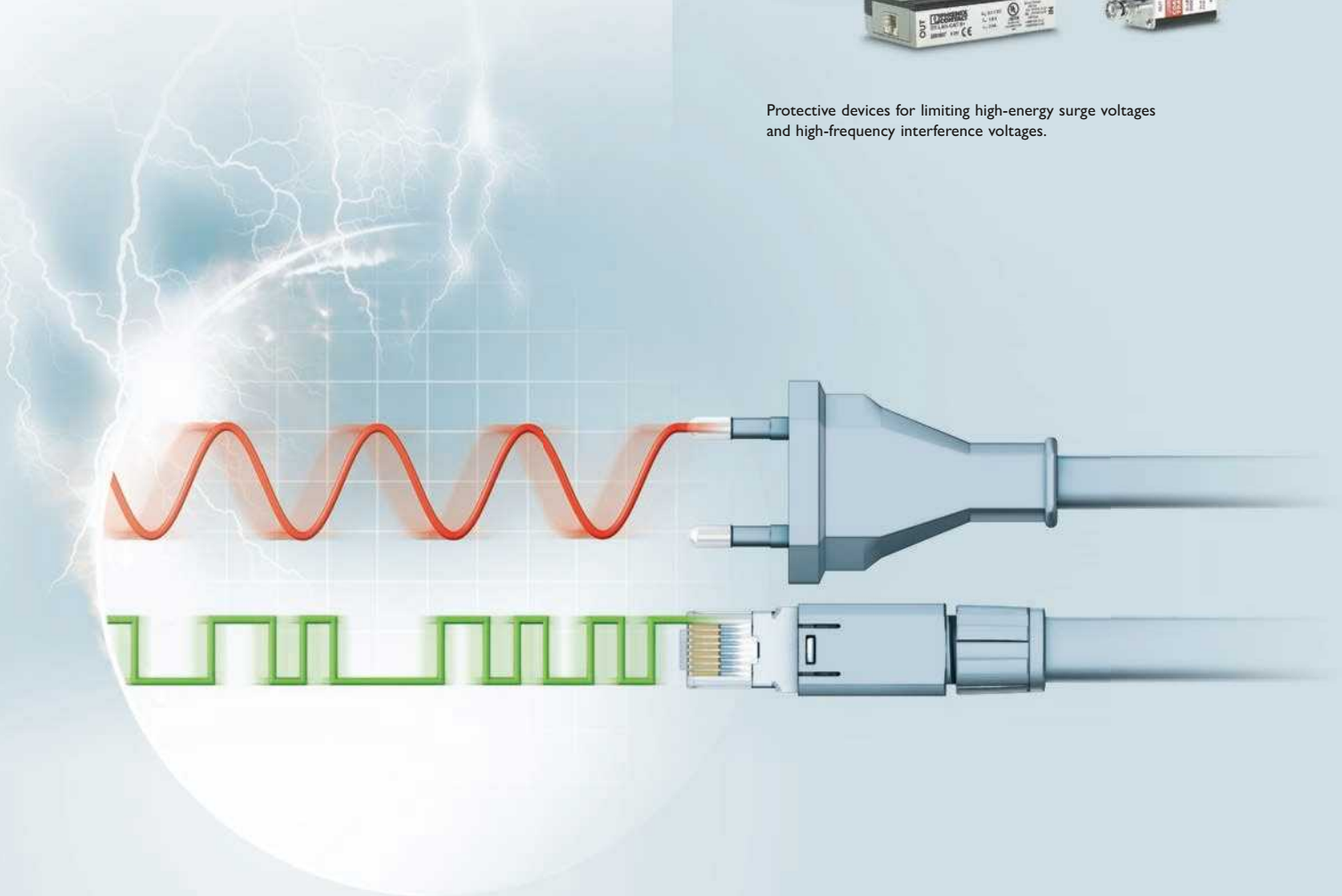

Surge voltages – an underestimated danger



Each day over four million lightning strikes occur all over the world.*

Ten percent of these are cloud-to-ground lightning strikes with surge currents up to 200,000 amperes. In addition to these four million lightning strikes that occur each day due to thunderstorms, surge voltages are also generated within local power grids. These are caused, for example, by switching operations, errors or switched-mode power supply units.

Whatever their cause, time and again surge voltages lead to unexpected device faults or system failures. TRABTECH surge protection provides comprehensive and effective protection against such effects.

* Source: de.wikipedia.org > Blitze (lightning)

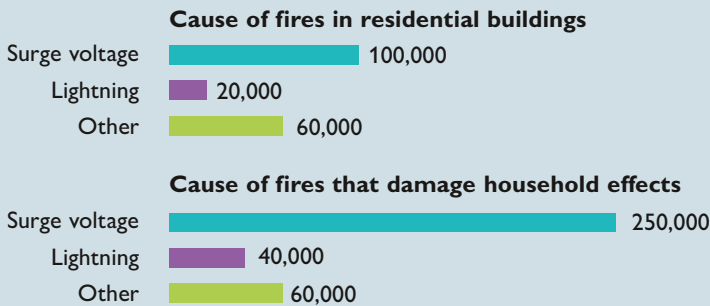

Device failure or defects caused by surge voltages are more frequent than expected. According to the statistics of the German Insurance Association (GDV), surge voltages are the most common cause of damage. These figures only apply to damage that resulted in fire.

Source: GDV - German Insurance Association 2013

Contents

| | |
|--|----|
| All-round safety with the protective circuit | 4 |
| Surge protection for the power supply | 6 |
| Surge protection for measurement and control technology | 16 |
| Surge protection for the Ex area | 20 |
| Surge protection for information technology | 24 |
| Surge protection for transceiver systems | 28 |
| CHECKMASTER 2 – the test system for surge protective devices | 32 |
| Lightning monitoring system with LM-S | 34 |
| Mains interference filters for power supplies and measurement signals | 36 |

All-round safety with the protective circuit

The protective circuit principle defines complete protection against surge voltages. An imaginary circle is drawn around the devices, plants or systems to be protected. Surge protective devices that correspond to the nominal data of the relevant power supply or signal type should be installed at all points where cables intersect this circle. In order to provide objects with consistent protection against conducted surge voltage couplings, the following areas should be taken into consideration:

■ Power supply

Optimally coordinated arresters for supplies, distributors and terminal devices safeguard the power supply.

■ MCR technology

Optimized arresters are available for a wide range of signal types and measuring principles.

■ Information technology

High-speed protection (CAT.6+) for data and communication technology.

■ Transceiver technology

So that private mobile radio and mobile communication as well as satellite or radio systems have reception whatever the weather.

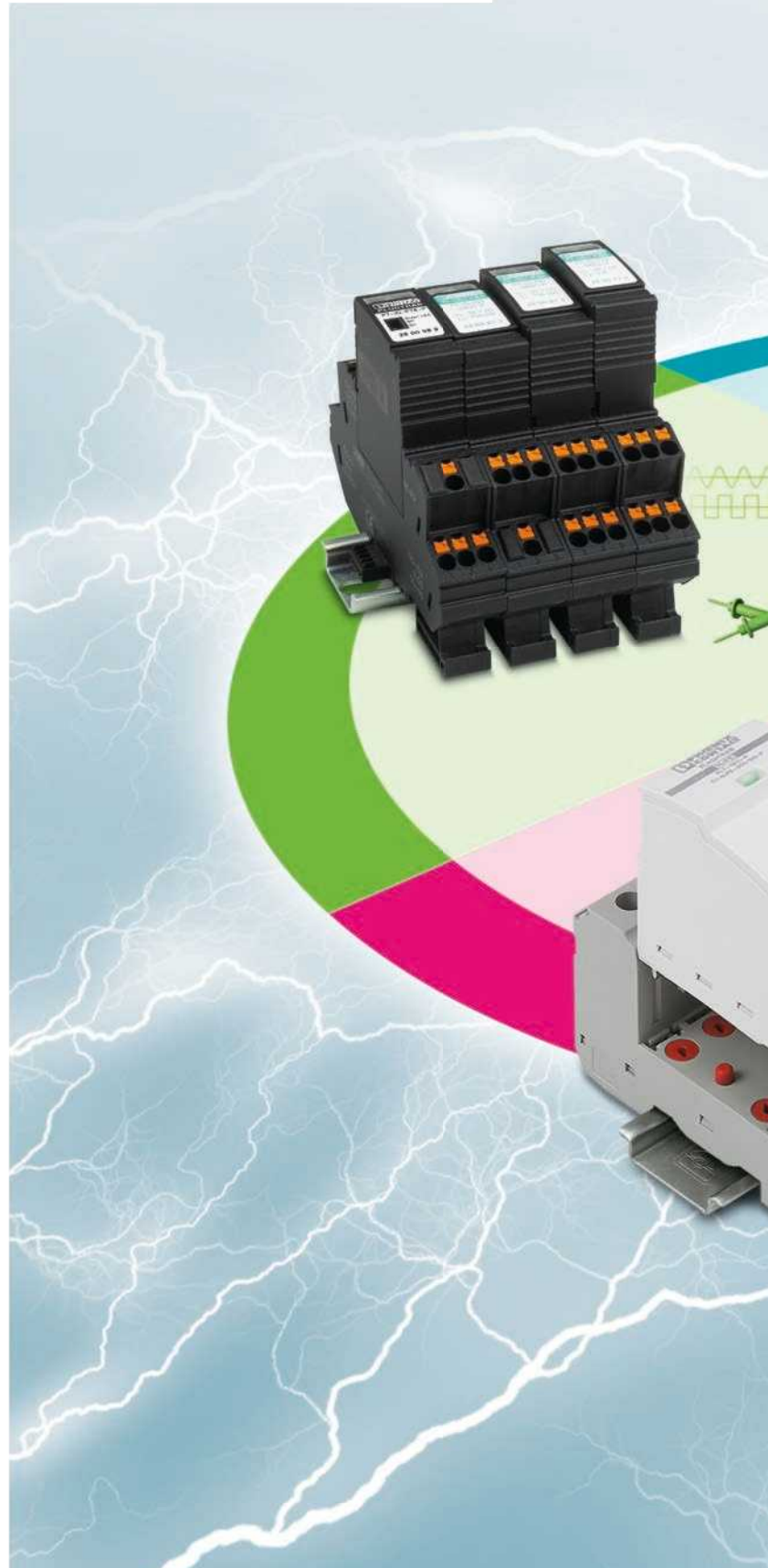



Surge protection for the power supply

Safe Energy Control, or SEC for short, represents nonreactive, powerful surge protection technology. The protective devices work discreetly in the background, providing consistent safeguarding for the entire system – including the backup fuses – even in cases where high lightning surge currents are being discharged.

The SEC family can be found in our extensive product range and includes type 1, type 2 and type 3 protective devices for all applications.

Besides its compact design and pluggability the SEC family's numerous user-friendly product features create an overall package that is easy to install.



Large-surface marking areas

Each individual connector can be marked either directly on the connector or by using a label.



Plugging instead of screwing

Consistent pluggability ensures a high degree of convenience in processes such as insulation measurements in the system. Instead of accessing the installation, just pull out the connector.



Just one turn

The protective devices support variable installation. This avoids unnecessarily long cables and offers optimum protection for every installation environment.



Status at a glance

Each connector has its own display to indicate its function status. What's more, a large area for applying your own marking is provided.



Remote signaling

A common floating changeover contact enables remote signaling without taking up extra space.

FLASHTRAB-SEC-HYBRID:

A powerful lightning current arrester with integrated arrester backup fuse

- Combination of spark gap without mains follow current and surge-proof fuse
- Can be used without separate backup fuse thanks to integrated overcurrent protection
- Arrester free of leakage, suitable for use in the unmetered area
- For use in 230/400 V systems with short-circuit output up to 100 kA and up to 50 kA in 400/690 V systems
- Plugs can be tested with CHECKMASTER 2



1-phase TN-C systems

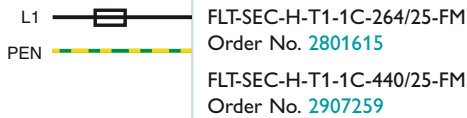

2-conductor system



3-phase TN-C systems

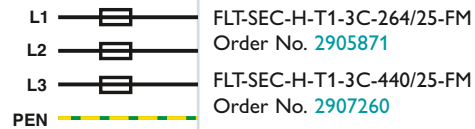

4-conductor system



| FLT-SEC-H... | ...-T1-1C-264/25 | ...-T1-3C-264/25 | ...-T1-1C-440/25 | ...-T1-3C-440/25 |
|--|------------------|------------------|------------------|------------------|
| IEC test classification/EN type | I/II, T_1/T_2 | | | |
| Nominal voltage U_N | 240 V AC | | 400 V AC | |
| Maximum continuous voltage U_c | 264 V AC | | 440 V AC | |
| Short-circuit withstand capability I_{SCCR} | 100 kA | | 50 kA | |
| Lightning impulse current I_{imp} (10/350) μ s/channel | | | 25 kA | |
| Nominal discharge current I_n (8/20) μ s/channel | | | 25 kA | |
| Voltage protection level U_p | ≤ 1.5 kV | | ≤ 2.5 kV | |
| Maximum backup fuse in acc. with IEC 61643-11 | Integrated | | | |

Type 1 lightning current arrester

FLASHTRAB-SEC-PLUS-440:

The compact power package for 400/690 V

- Spark gap without mains follow current
- Arrester free of leakage, suitable for use in the unmetred area
- Satisfies TOV requirements for use in IT systems
- High level of lightning current discharge capacity of 35 kA per position
- Fuse-free use up to 400 A gG
- Low voltage protection level of ≤ 2.5 kV
- Plugs can be tested with CHECKMASTER 2



3-phase TN-S-/TT systems

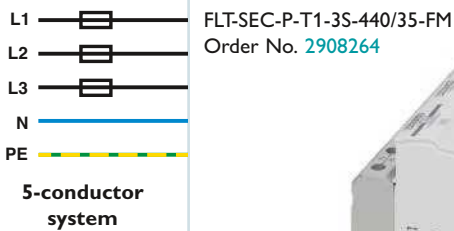

1-pos. module

FLT-SEC-P-T1-1C-440/35-FM
 Order No. 2905987



3-phase TN-C-/IT systems

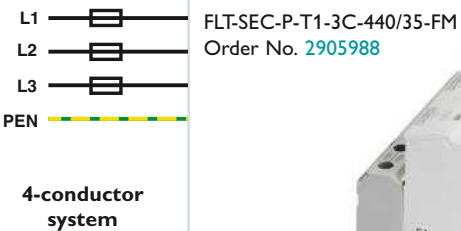

N-PE spark gap

FLT-SEC-P-T1-N/PE-440/100-FM
 Order No. 2907262



| FLT-SEC-P.. | ...-T1-3S-440/35 | ...-T1-3C-440/35 | ...-T1-1C-440/35 | ...-T1-N/PE-440/100 |
|--|------------------|------------------|------------------|---------------------|
| IEC test classification/EN type | I/II, T1/T2 | | | |
| Nominal voltage U_N | 400/690 V AC | | | 400 V AC |
| Maximum continuous voltage U_C | 440 V AC | | | |
| Short-circuit withstand capability I_{SCCR} | 50 kA | | | |
| Lightning impulse current I_{imp} (10/350) μ s/channel | 35 kA | | | 100 kA |
| Nominal discharge current I_n (8/20) μ s/channel | 35 kA | | | 100 kA |
| Voltage protection level U_p | ≤ 2.5 kV | | | |
| Maximum backup fuse in acc. with IEC 61643-11 | 400 A gG | | | |

FLASHTRAB-SEC-PLUS-350:

A compact lightning current arrester for powerful systems

- Spark gap without mains follow current
- Arrester free of leakage, suitable for use in the unmetred area
- For use in 230/400 V systems with short-circuit output up to 100 kA
- Fuse-free use up to 315 A gG
- Low voltage protection level of ≤ 1.5 kV
- Plugs can be tested with CHECKMASTER 2



TN-S/TT systems

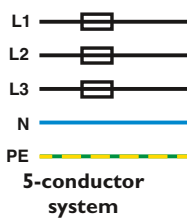

FLT-SEC-P-T1-3S-350/25-FM
Order No. 2905421

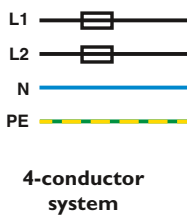

FLT-SEC-P-T1-2S-350/25-FM
Order No. 2905418

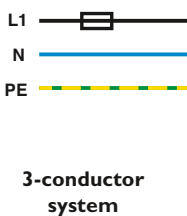

FLT-SEC-P-T1-1S-350/25-FM
Order No. 2905415



TN-C systems

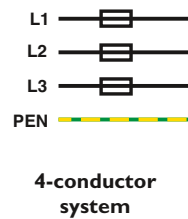

FLT-SEC-P-T1-3C-350/25-FM
Order No. 2905419

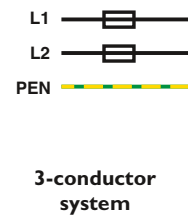

FLT-SEC-P-T1-2C-350/25-FM
Order No. 2905416

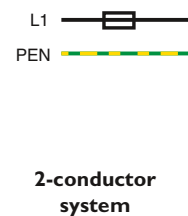

FLT-SEC-P-T1-1C-350/25-FM
Order No. 2905414



| FLT-SEC-P.. | ...-T1-3S-350 | ...-T1-3C-350 | ...-T1-2S-350 | ...-T1-2C-350 | ...-T1-1S-350 | ...-T1-1C-350 |
|--|-------------------------------|---------------|---------------|---------------|-----------------------|---------------|
| IEC test classification/EN type | I/II, T1/T2 | | | | | |
| Nominal voltage U_N | 230/400 V AC ... 240/415 V AC | | | | 230 V AC ... 240 V AC | |
| Maximum continuous voltage U_C | 350 V AC L-N (L-PEN) | | | | | |
| Short-circuit withstand capability I_{SCCR} | 100 kA (264 V AC) | | | | | |
| Lightning impulse current I_{imp} (10/350) μ s | 100 kA | 75 kA | 75 kA | 50 kA | 50 kA | 25 kA |
| Nominal discharge current I_n (8/20) μ s | 100 kA | 75 kA | 75 kA | 50 kA | 50 kA | 25 kA |
| Voltage protection level U_p | ≤ 1.5 kV | | | | | |
| Maximum backup fuse in acc. with IEC 61643-11 | 315 A gG | | | | | |

Type 1 lightning current arrester

FLASHTRAB-SEC-PLUS-264:

A powerful lightning current arrester for extremely high lightning currents

- Spark gap without mains follow current
- Arrester free of leakage, suitable for use in the unmetered area
- Fuse-free use up to 500 A gG
- Installation effort reduced to a minimum
- High level of lightning current discharge capacity of 50 kA per position
- Low voltage protection level of ≤ 2.5 kV
- Plugs can be tested with CHECKMASTER 2



3-phase TN-C systems

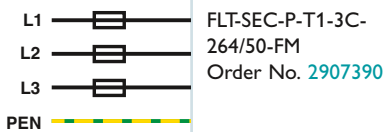

4-conductor system



1-phase TN-S systems



3-conductor system



1-phase TN-C systems



2-conductor system



| FLT-SEC-P.. | ...-T1-3C-264/50 | ...-T1-1S-264/50 | ...-T1-1C-264/50 |
|--|------------------|------------------|------------------|
| IEC test classification/EN type | | I/II, T1/T2 | |
| Nominal voltage U_N | 240/415 V AC | | 240 V AC |
| Maximum continuous voltage U_C | | 264 V AC | |
| Short-circuit withstand capability I_{SCCR} | | 50 kA | |
| Lightning impulse current I_{imp} (10/350) μ s/channel | | 50 kA | |
| Nominal discharge current I_n (8/20) μ s/channel | | 50 kA | |
| Voltage protection level U_p | | ≤ 2.5 kV | |
| Maximum backup fuse in acc. with IEC 61643-11 | | 500 A gG | |



FLASHTRAB-SEC-T1+T2:

Combined lightning current arrester and surge protective device

- Type 1 and type 2 protective devices directly coordinated
- For use in main current distribution/industrial distribution, within the post-meter area
- Fuse-free use up to 315 A gG
- Installation work reduced to a minimum
- Low voltage protection level of ≤ 1.5 kV
- Plugs can be tested with CHECKMASTER 2



TN-S/TT systems

L1 ——— ———
 L2 ——— ———
 L3 ——— ———
 N ——— ———
 PE ——— ———

FLT-SEC-T1+T2-3S-350/25-FM
Order No. 2905470

5-conductor system

L1 ——— ———
 L2 ——— ———
 N ——— ———
 PE ——— ———

FLT-SEC-T1+T2-2S-350/25-FM
Order No. 2905468

4-conductor system

L1 ——— ———
 N ——— ———
 PE ——— ———

FLT-SEC-T1+T2-1S-350/25-FM
Order No. 2905466

3-conductor system

TN-C systems

L1 ——— ———
 L2 ——— ———
 L3 ——— ———
 PEN ——— ———

FLT-SEC-T1+T2-3C-350/25-FM
Order No. 2905469

4-conductor system

L1 ——— ———
 L2 ——— ———
 PEN ——— ———

FLT-SEC-T1+T2-2C-350/25-FM
Order No. 2905467

3-conductor system

L1 ——— ———
 PEN ——— ———

FLT-SEC-T1+T2-1C-350/25-FM
Order No. 2905465

2-conductor system

| FLT-SEC-T1+T2... | ...3S-350 | ...3C-350 | ...2S-350 | ...2C-350 | ...1S-350 | ...1C-350 |
|--|-------------------------------|-----------|-----------|-----------|-----------------------|-----------|
| IEC test classification/EN type | I+II, T1+T2 | | | | | |
| Nominal voltage U_N | 230/400 V AC ... 240/415 V AC | | | | 230 V AC ... 240 V AC | |
| Maximum continuous voltage U_C | 350 V AC L-N (L-PEN) | | | | | |
| Short-circuit withstand capability I_{SCCR} | 25 kA (264 V AC) | | | | | |
| Lightning impulse current I_{imp} (10/350) μ s | 100 kA | 75 kA | 75 kA | 50 kA | 50 kA | 25 kA |
| Nominal discharge current I_n (8/20) μ s | 100 kA | 75 kA | 75 kA | 50 kA | 50 kA | 25 kA |
| Voltage protection level U_p | ≤ 1.5 kV | | | | | |
| Maximum backup fuse in acc. with IEC 61643-11 | 315 A gG | | | | | |

Type 2 surge protective device



VALVETRAB-SEC-T2:

Space-saving surge protection



- Type 2 surge protective device
- For use in sub-distribution and floor distribution before the residual current protective device
- Fuse-free use up to 315 A gG
- Overall width of just 12 mm per channel
- Low voltage protection level of ≤ 1.5 kV
- Plugs can be tested with CHECKMASTER 2



TN-S/TT systems

| | |
|---|---|
| L1 — — L2 — — L3 — — N — — PE — — 5-conductor system | VAL-SEC-T2-3S-350-FM Order No. 2905340  |
| L1 — — L2 — — N — — PE — — 4-conductor system | VAL-SEC-T2-2S-350-FM Order No. 2905338  |
| L1 — — N — — PE — — 3-conductor system | VAL-SEC-T2-1S-350-FM Order No. 2905333  |

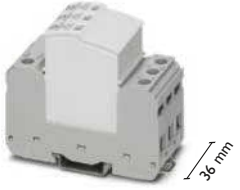
TN-C systems

| | |
|--|---|
| L1 — — L2 — — L3 — — PEN — — 4-conductor system | VAL-SEC-T2-3C-350-FM Order No. 2905339  |
| L1 — — L2 — — PEN — — 3-conductor system | VAL-SEC-T2-2C-350-FM Order No. 2905337  |

| VAL-SEC-T2... | ...3S-350 | ...3C-350 | ...2S-350 | ...2C-350 | ...1S-350 |
|---|-------------------------------|-----------|-----------|-----------|-----------------------|
| IEC test classification/EN type | II, T2 | | | | |
| Nominal voltage U_N | 230/400 V AC ... 240/415 V AC | | | | 230 V AC ... 240 V AC |
| Maximum continuous voltage U_c | 350 V AC L-N (L-PEN) | | | | |
| Short-circuit withstand capability I_{SCCR} | 50 kA (max. 200 A gG) | | | | |
| Nominal discharge current I_n (8/20) μ s/channel | 20 kA | | | | |
| Max. discharge surge current I_{max} (8/20) μ s/channel | 40 kA | | | | |
| Voltage protection level U_p | ≤ 1.5 kV | | | | |
| Maximum backup fuse in acc. with IEC 61643-11 | 315 A gG | | | | |

Note: VALVETRAB SEC is also available for 120 V power supply systems.

Combi-RCD*: surge protection with residual current protective device



| Residual current device (RCD) | Surge protective device (VAL-CP) |
|--|--|
| Sensitive to residual currents: Type A | IEC test classification/EN type: II, $\overline{T2}$ |
| Rated residual current $I_{\Delta n}$: 30 mA/300 mA | Discharge surge current I_{max} (8/20) μ s: 30 kA/path |
| Tripping time for $I_{\Delta n}$: ≤ 300 ms | Maximum continuous voltage U_C : 350 V AC |

VAL-CP-RCD-3S/40/0.03

Order No. [2882802](#)

VAL-CP-RCD-3S/40/0.3/SEL

Order No. [2808001](#)

Nominal voltage U_N : 230/400 ... 240/415 V AC

Nominal load current I_L : 40 A



Dimensions (W x H x D): 120 mm x 90 mm x 75 mm

The Combi-RCD combines the properties of a residual current protective device* with those of a type 2 surge protective device in a single housing. This innovative 2-in-1-concept provides simultaneous protection for people and devices.

* Residual current device = RCD

Combi-MCB: surge protection with coordinated backup fuse**



| | | |
|---|--|---|
|  |  |  |
| VAL-CP-MCB-3S-350/40/FM Order No. 2882750 | VAL-CP-MCB-3C-350/40/FM Order No. 2882776 | VAL-CP-MCB-1S-350/40/FM Order No. 2882763 |
| IEC test classification/EN type: II, $\overline{T2}$ | | |
| Nominal voltage U_N : 230/400 V AC ... 240/415 V AC | | |
| Maximum continuous voltage U_C : 350 V AC | | |
| Nominal discharge current I_n (8/20) μ s: 20 kA/path | | |
| Voltage protection level U_p : ≤ 2.5 kV | | |

The integrated arrester backup fuses of the VAL-CP-MCB ensure the maximum utilization of the performance capabilities of the surge protection. Their use is not dependent on the operating current fuses in the system – faults relating to the safeguarding of surge protection are therefore prevented.

** Mains circuit breaker = MCB

Type 3 device protection

Type 3 surge protective device – PLUGTRAB-SEC-T3:

Space-saving surge protection

- Type 3 surge protective device
- For use in AC and DC applications
- Integrated surge-proof fuse
- With an overall width of only 17.5 mm
- Low voltage protection level
- Plugs can be tested with CHECKMASTER 2



PLUGTRAB: TN-S/TT systems

| | |
|---|---|
| <p>L1 </p> <p>L2 </p> <p>L3 </p> <p>N </p> <p>PE </p> | |
| 230 V / 400 V | PLT-SEC-T3-3S-230-FM Order No. 2905230 |

PLUGTRAB: TN-S/TT/IT systems

| | |
|---------------------------------|--|
| <p>L1 </p> <p>N </p> <p>PE </p> | |
| 230 V | PLT-SEC-T3-230-FM Order No. 2905229 |
| 120 V | PLT-SEC-T3-120-FM Order No. 2905228 |
| 60 V | PLT-SEC-T3-60-FM Order No. 2905225 |
| 24 V | PLT-SEC-T3-24-FM Order No. 2905223 |

| PLT-SEC... | ...-T3-3S-230 | ...-T3-230 | ...-T3-120 | ...-T3-60 | ...-T3-24 |
|---|------------------------------|-------------------------------|----------------------------|----------------------------|----------------------------|
| Nominal voltage U_N | 230 V | 230 V | 120 V | 60 V | 24 V |
| Maximum continuous voltage U_C | 264 V AC | 264 V AC/230 V DC | 150 V AC/DC | 100 V AC/80 V DC | 34 V AC/DC |
| Nominal current I_N | | | 26 A | | |
| Nominal discharge current I_n (8/20) μ s | 3 kA (per channel) | 3 kA | 3 kA | 2 kA | 1 kA |
| Combined surge U_{oc} | | 6 kV | | 4 kV | 2 kV |
| Voltage protection level U_p : L-N / L(N)-PE | ≤ 1.4 kV/ ≤ 1.5 kV | ≤ 1.35 kV/ ≤ 1.5 kV | ≤ 850 V/ ≤ 950 V | ≤ 480 V/ ≤ 900 V | ≤ 250 V/ ≤ 650 V |

Type 3 device protection

MAINTRAB: TN-S/TT systems



Socket adapter for protecting the power supply.



230 V

| | | |
|---------------------------|-------------|-----------------------------------|
| DE, AT, NL, ES, SE | MNT-1D | Order No. 2882200 |
| BE, FR, CZ, PL, SK | MNT-NET B/F | Order No. 2882226 |
| CH | MNT-1 CH II | Order No. 2882255 |

MAINTRAB PLUS: TN-S/TT systems



Socket adapter combined with antenna or telecommunications protection.



230 V

| | | | |
|-------------------------------|-------------------------|----------------|-----------------------------------|
| DE, AT, NL, FI, ES, SE | ...with SAT connection | MNT-TV-SAT D | Order No. 2882284 |
| | ...with ISDN connection | MNT-ISDN D | Order No. 2882336 |
| | ...with TAE connection | MNT-TAE D | Order No. 2882381 |
| | ...with RJ12 connection | MNT-TELE E | Order No. 2882417 |
| BE, FR, CZ, SK, PL | ...with SAT connection | MNT-TV-SAT B/F | Order No. 2882307 |
| | ...with RJ12 connection | MNT-TEL B/F | Order No. 2882404 |

BLOCKTRAB: TN-S/TT/IT systems

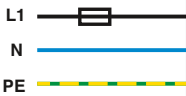

For universal mounting in equipment such as distribution boxes, junction boxes or cable ducts.

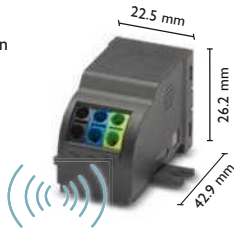

230 V

BT-1S-230AC/A
Order No. [2803409](#)



For universal mounting in equipment such as distribution boxes, junction boxes or cable ducts.



BT-1S-230AC/O
Order No. [2800625](#)

Type 2 surge protective device and type 3 device protection

BLOCKTRAB: TN-S/TT systems



For direct installation in the lamp or in the cable terminal box in the post. Switching version for lamps with insulated connection.



BLT-T2-320-UT
Order No. [2906100](#)

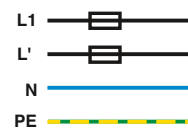

For direct installation in the lamp or in the cable terminal box in the post. Switching version for lamps with grounded connection.



BLT-T2-1S-320-UT
Order No. [2906101](#)

Surge protection for measurement and control technology

Signal interfaces are particularly sensitive to surge voltages. Combined circuit breakers with components which are powerful and respond quickly are the right solution in these cases.

The protective devices from the PLUGTRAB product range also boast practical functions. The pluggability of the arresters enables function checks to be performed easily and replacements made quickly – even during system operation.

This selection guide helps you find the right protection for your application quickly and easily – providing you with greater availability.

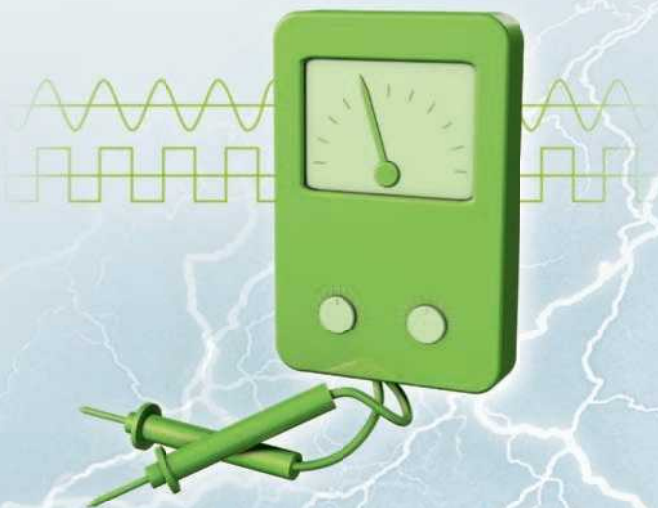

Vibration-resistant installation

The latching mechanism guarantees a secure fit for installations in harsh environments. It holds the plug in place in the base element even in the event of extremely strong vibrations.



Error-free installation

Voltage coding and protection against polarity reversal make incorrect connection impossible.



Space-saving installation

Up to five signal lines can be protected with one device. This requires an overall width of just 17.5 mm on the DIN rail, meaning only 3.5 mm per signal line.

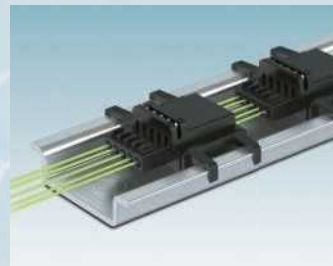

Fast installation

Individual DIN rail connectors can be converted into a bus. This transmits the power supply and status information. Conventional wiring is not used.



Variable connection technology

Choose between the classic screw connection or push-in connection technology which is even faster to wire.

Intelligent and systematic surge protection

PLUGTRAB PT-IQ is a range of self-monitoring surge protective devices with multi-stage status indicator. A controller supplies up to 28 protection modules with voltage via a DIN rail connector, collects the status of all connected protective devices and provides the connection for central remote signaling. A surge protective device consists of the plug, base element and DIN rail connector adapter.

Energy efficiency

The green LEDs on all protection modules can be switched off centrally at the controller.

PT-IQ-PTB-P

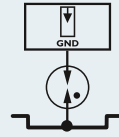

Indirect grounding

In the case of the **PT...+F... and +F-BE modules**, the connections for the shield and the reference potential are connected to the metal mounting foot and therefore the DIN rail via a gas-filled surge arrester.

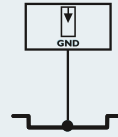

Direct grounding

In the case of the **PT...-UT and -BE modules**, the connections for the shield and the reference potential are connected to the DIN rail via the metal mounting foot.

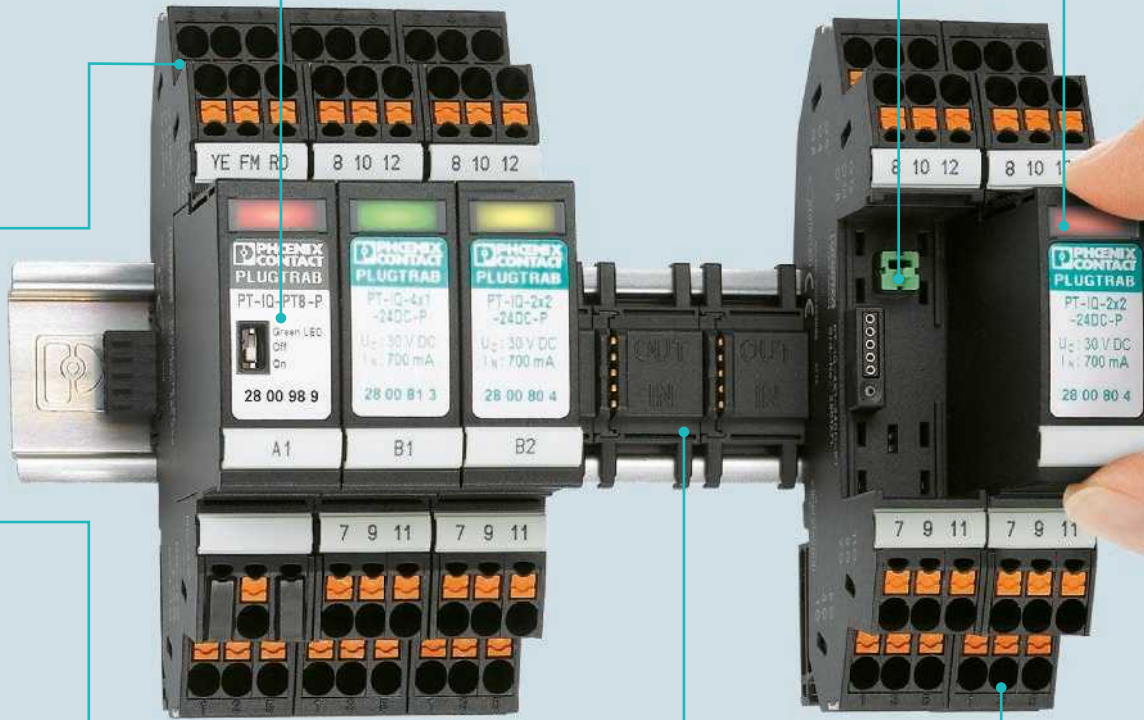

- OK
- Performance limit reached, replacement recommended
- Overloaded, replacement required

Surge protection with push-in and screw connection technology

Controller for power supply and remote signaling

One controller for each of the PT-IQ... protective devices (maximum 28)



| | | |
|---------|--------------|--------------------|
| 2801296 | PT-IQ-PTB-PT | Push-in connection |
| 2800768 | PT-IQ-PTB-UT | Screw connection |

Telecommunications



| | | |
|---------|-------------------|--------------------|
| 2801290 | PT-IQ-1X2-TELE-PT | Push-in connection |
| 2800769 | PT-IQ-1X2-TELE-UT | Screw connection |

Protection for two conductors

Binary switching signals





| Indirect grounding | | Direct grounding | | |
|--------------------|---------------------|------------------|-------------------|--------------------|
| 2801244 | PT-IQ-2X1+F-5DC-PT | 2801243 | PT-IQ-2X1-5DC-PT | Push-in connection |
| 2801246 | PT-IQ-2X1+F-12DC-PT | 2801245 | PT-IQ-2X1-12DC-PT | |
| 2801248 | PT-IQ-2X1+F-24DC-PT | 2801247 | PT-IQ-2X1-24DC-PT | |
| 2801250 | PT-IQ-2X1+F-48DC-PT | 2801249 | PT-IQ-2X1-48DC-PT | |
| 2800779 | PT-IQ-2X1+F-5DC-UT | 2800778 | PT-IQ-2X1-5DC-UT | Screw connection |
| 2800781 | PT-IQ-2X1+F-12DC-UT | 2800780 | PT-IQ-2X1-12DC-UT | |
| 2800788 | PT-IQ-2X1+F-24DC-UT | 2800787 | PT-IQ-2X1-24DC-UT | |
| 2800790 | PT-IQ-2X1+F-48DC-UT | 2800789 | PT-IQ-2X1-48DC-UT | |



Protection for four conductors



Binary switching signals

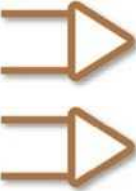

| Indirect grounding | | Direct grounding | | |
|--------------------|---------------------|------------------|-------------------|--------------------|
| 2801268 | PT-IQ-4X1+F-5DC-PT | 2801267 | PT-IQ-4X1-5DC-PT | Push-in connection |
| 2801270 | PT-IQ-4X1+F-12DC-PT | 2801269 | PT-IQ-4X1-12DC-PT | |
| 2801272 | PT-IQ-4X1+F-24DC-PT | 2801271 | PT-IQ-4X1-24DC-PT | |
| 2801274 | PT-IQ-4X1+F-48DC-PT | 2801273 | PT-IQ-4X1-48DC-PT | |
| 2801216 | PT-IQ-4X1+F-5DC-UT | 2801215 | PT-IQ-4X1-5DC-UT | Screw connection |
| 2801218 | PT-IQ-4X1+F-12DC-UT | 2801217 | PT-IQ-4X1-12DC-UT | |
| 2800983 | PT-IQ-4X1+F-24DC-UT | 2800982 | PT-IQ-4X1-24DC-UT | |
| 2801220 | PT-IQ-4X1+F-48DC-UT | 2801219 | PT-IQ-4X1-48DC-UT | |

| Protection for one double wire | Indirect grounding | | Direct grounding | | |
|--|--------------------|---------------------|------------------|-------------------|--------------------|
| Standard signals 0 ... 10 V 0/4 ... 20 mA   | 2801252 | PT-IQ-1X2+F-5DC-PT | 2801251 | PT-IQ-1X2-5DC-PT | Push-in connection |
| | 2801254 | PT-IQ-1X2+F-12DC-PT | 2801253 | PT-IQ-1X2-12DC-PT | |
| | 2801256 | PT-IQ-1X2+F-24DC-PT | 2801255 | PT-IQ-1X2-24DC-PT | |
| | 2801258 | PT-IQ-1X2+F-48DC-PT | 2801257 | PT-IQ-1X2-48DC-PT | |
| | 2800792 | PT-IQ-1X2+F-5DC-UT | 2800791 | PT-IQ-1X2-5DC-UT | Screw connection |
| | 2800975 | PT-IQ-1X2+F-12DC-UT | 2800793 | PT-IQ-1X2-12DC-UT | |
| | 2800977 | PT-IQ-1X2+F-24DC-UT | 2800976 | PT-IQ-1X2-24DC-UT | |
| | 2800979 | PT-IQ-1X2+F-48DC-UT | 2800978 | PT-IQ-1X2-48DC-UT | |

| Protection for two double wires | Indirect grounding | | Direct grounding | | |
|---|--------------------|---------------------|------------------|-------------------|--------------------|
| Standard signals 0 ... 10 V 0/4 ... 20 mA   | 2801260 | PT-IQ-2X2+F-5DC-PT | 2801259 | PT-IQ-2X2-5DC-PT | Push-in connection |
| | 2801262 | PT-IQ-2X2+F-12DC-PT | 2801261 | PT-IQ-2X2-12DC-PT | |
| | 2801264 | PT-IQ-2X2+F-24DC-PT | 2801263 | PT-IQ-2X2-24DC-PT | |
| | 2801266 | PT-IQ-2X2+F-48DC-PT | 2801265 | PT-IQ-2X2-48DC-PT | |
| | 2800809 | PT-IQ-2X2+F-5DC-UT | 2800807 | PT-IQ-2X2-5DC-UT | Screw connection |
| | 2800985 | PT-IQ-2X2+F-12DC-UT | 2800984 | PT-IQ-2X2-12DC-UT | |
| | 2800981 | PT-IQ-2X2+F-24DC-UT | 2800980 | PT-IQ-2X2-24DC-UT | |
| | 2800987 | PT-IQ-2X2+F-48DC-UT | 2800986 | PT-IQ-2X2-48DC-UT | |

| Data technology | Indirect grounding | | Direct grounding | | |
|--|--------------------|----------------------|------------------|--------------------|--------------------|
|   | 2801287 | PT-IQ-3-PB+F-PT | 2801286 | PT-IQ-3-PB-PT | Push-in connection |
| | 2801289 | PT-IQ-3-HF+F-12DC-PT | 2801288 | PT-IQ-3-HF-12DC-PT | |
| | 2801292 | PT-IQ-5-HF+F-5DC-PT | 2801291 | PT-IQ-5-HF-5DC-PT | |
| | 2801295 | PT-IQ-5-HF+F-12DC-PT | 2801293 | PT-IQ-5-HF-12DC-PT | |
| | 2800994 | PT-IQ-3-PB+F-UT | 2800785 | PT-IQ-3-PB-UT | Screw connection |
| | 2800995 | PT-IQ-3-HF+F-12DC-UT | 2800786 | PT-IQ-3-HF-12DC-UT | |
| | 2800798 | PT-IQ-5-HF+F-5DC-UT | 2800797 | PT-IQ-5-HF-5DC-UT | |
| | 2800801 | PT-IQ-5-HF+F-12DC-UT | 2800799 | PT-IQ-5-HF-12DC-UT | |

Surge protection for the Ex area

With the PLUGTRAB PT-IQ Ex protective devices, it is possible for the first time to install protective devices with multi-stage monitoring and remote signaling directly in Ex zone 2. The intrinsically safe protective circuits can be led up to Ex zone 0.

Your advantage: you can check the status of your protective devices directly on site or in the control room, even in intrinsically safe areas. You can replace the modules before a failure occurs.



Benefit from all the advantages of the surge protection system, even in the Ex area. You can monitor up to ten PT-IQ Ex surge protective devices using a central controller.

Zone classification in the Ex area

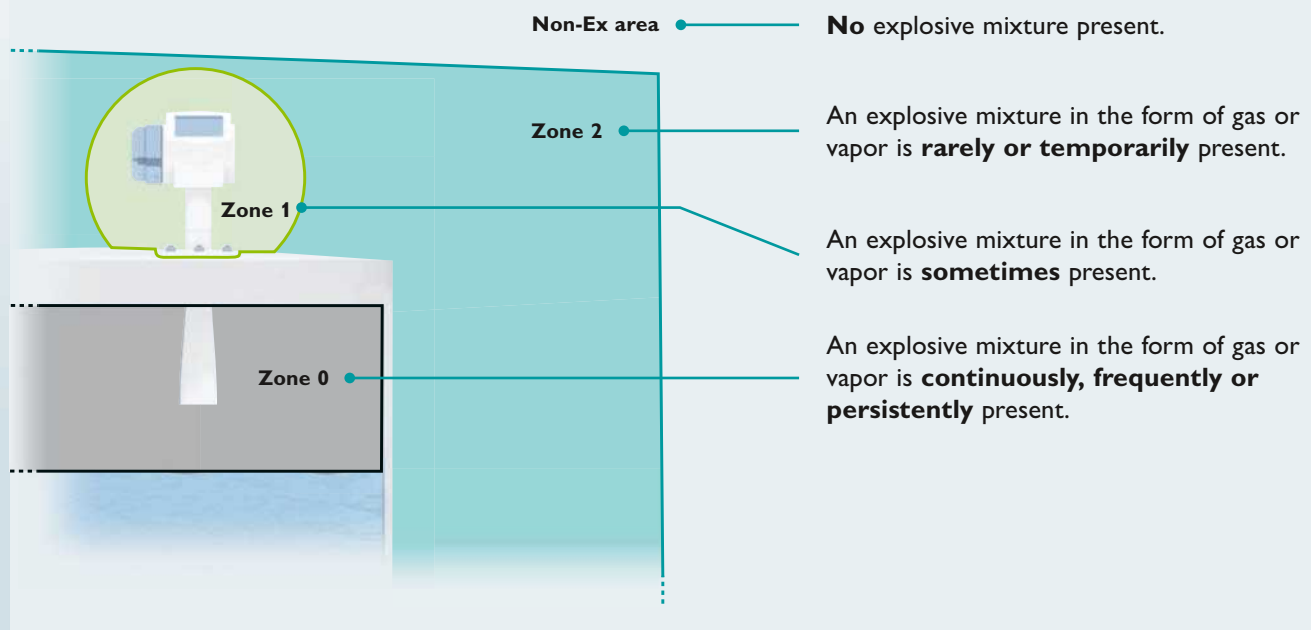

Intelligent surge protection for the Ex area

Controller for power supply and remote signaling

One controller for each of the PT-IQ...EX... protective devices (maximum 10)



2800768

PT-IQ-PTB-UT

Protection for one double wire

Standard signals
0 ... 10 V
0/4 ... 20 mA



2801512

PT-IQ-1X2-EX-24DC-UT

Protection for two double wires

Standard signals
0 ... 10 V
0/4 ... 20 mA



2801513

PT-IQ-2X2-EX-24DC-UT

Necessary accessories: partition plates

Partition plates for maintaining the minimum distance of 50 mm between the controller and Ex protection modules.



2905023

PT-IQ-EX-L-PP

For isolated DIN rails

2905024

PT-IQ-EX-H-PP









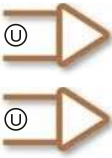

Pluggable surge protection – PLUGTRAB PT

PLUGTRAB PT consists of a base element and a protective plug. Various grounding options are implemented via the corresponding base element. Each protective plug can be tested using the CHECKMASTER arrester testing device.

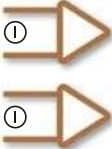
All the PLUGTRAB PT devices listed below are available for any application – and that includes the convenient PT-IQ type.



Floating signal circuits

| The products on this page support the HART protocol** | Plugs | Base element | | |
|---|--|--------------------|--|--|
| | | Indirect grounding | Direct grounding | |
|  <p>Protection for 1 double wire*, e.g., standard signals 0 ... 10 V 0/4 ... 20 mA</p> |  <p>PT 1x2-12DC-ST Order No. 2856029</p> <hr/> <p>PT 1x2-24DC-ST Order No. 2856032</p> | + | <p>PT 1x2+F-BE Order No. 2856126</p> | <p>PT 1x2-BE Order No. 2856113</p> |
|  <p>Protection for 2 double wires*, e.g., standard signals 0 ... 10 V 0/4 ... 20 mA</p> |  <p>PT 2x2-12DC-ST Order No. 2838254</p> <hr/> <p>PT 2x2-24DC-ST Order No. 2838228</p> | + | <p>PT 2x2+F-BE Order No. 2839224</p> | <p>PT 2x2-BE Order No. 2839208</p> |
|  <p>Protection for intrinsically safe circuits, one or two double wires</p> |  <p>PT 2xEX(I)-24DC-ST Order No. 2838225</p> | + | – | <p>PT 2xEX(I)-BE Order No. 2839279</p> |
|  <p>Protection for temperature, 2, 3 or 4-conductor measurements</p> |  <p>PT 4-24DC-ST Order No. 2839240</p> | + | <p>PT 4+F-BE Order No. 2839415</p> | <p>PT 4-BE Order No. 2839402</p> |
|  <p>Protection for intrinsically safe circuits, 2, 3 or 4-conductor measurements</p> |  <p>PT 4-EX(I)-24DC-ST Order No. 2839253</p> | + | – | <p>PT 4-EX(I)-BE Order No. 2839486</p> |

* Other voltage levels are available at www.phoenixcontact.com

** HART = Highway Addressable Remote Transducer Protocol (Phoenix Contact is a registered member of the HART Communication Foundation)

Signal circuits with common reference potential



| | | Plugs | | Base element | | |
|--|---|-------|---|--------------------|--|--|
| | | | | Indirect grounding | Direct grounding | |
| | Protection for two conductors*, e.g., binary switching signals | | PT 2x1- 24DC -ST Order No. 2856087 | + | PT 2x1-F-BE Order No. 2856142 | PT 2x1-BE Order No. 2856139 |
| | | | PT 2x1- 24AC -ST Order No. 2856100 | | | |
| | Protection for four conductors*, e.g., binary switching signals | | PT 4x1- 24DC -ST Order No. 2838322 | + | PT 4x1-F-BE Order No. 2839376 | PT 4x1-BE Order No. 2839363 |
| | | | PT 4x1- 24AC -ST Order No. 2838351 | | | |
| | Protection for high signal voltages* | | PT 2x1VA- 120AC -ST Order No. 2839185 | + | - | PT-BE/FM Order No. 2839282 |
| | | | PT 2x1VA- 230AC -ST Order No. 2839198 | | | |

Single-stage protection with gas-filled surge arrester as coarse protection



| | | | | | | |
|--|--------------------------------|--|--|---|---|---|
| | Protection for two conductors | | PT 2-F-ST Order No. 2859000 | + | - | PT-BE/FM Order No. 2839282 |
| | Protection for four conductors | | PT 4-F-ST Order No. 2858441 | | | |

TERMITRAB



Protection in the terminal block

The multi-stage surge protective devices for protecting a double wire serve as fine and medium protection between the signal wires and as coarse protection between the signal wires and the ground. With screw or spring connection and as version with disconnect knives.

SURGETRAB



Protection directly at the measuring head

The surge protective devices for measuring heads. The screw-on modules are available for all common standard signals. The extremely robust housing made from V4A stainless steel protects against unwanted outages even in rough industrial environments and is ready to be used in the Ex area.

LINETRAB



The standard in the 6.2 mm class

The LINETRAB DIN rail modules protect up to 4 signal paths simultaneously. 4-conductor measurements can be carried out in a limited amount of space. A DIN rail connector system is available for compact protection of interfaces with more than 4 signal wires. This allows you to combine an unlimited number of protection modules to create a single switching unit that can be used in processes such as 6-conductor measurements.

Surge protection for information technology

Reliable data and telecommunications are indispensable in today's industry. The sensitive systems used in these cases work with high frequencies at low signal levels and are networked over a wide area. Surge voltages here quickly lead to large-scale failures and, in the worst-case scenario, to data loss.

This selection guide helps you find the right protection for your application quickly and easily – providing you with greater availability.

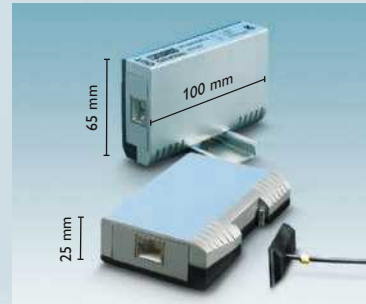

The perfect fit

The DATATRAB series can be used as an adapter or DIN rail module.



Modular, small and easy

Protective plugs for telecommunications and data distributors. The COMTRAB product range for LSA-PLUS disconnect strips.







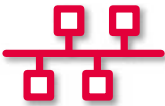

Numerous applications, one solution

Solutions based on the PLUGTRAB series provide the ideal protection for installation in the control cabinet.

Information and data technology (bus systems)

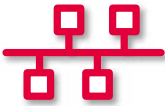
| | | Plugs | | Base element |
|--|---------------------------------------|---|---|--|
|  | PROFIBUS DP |  | PT 3-PB-ST Order No. 2858030 | + PT 1X2-BE Order No. 2856113 |
| | INTERBUS-INLINE (I/O) Digital | | PT 4X1-24AC-ST Order No. 2838351 | + PT 4X1-BE Order No. 2839363 |
| | INTERBUS-INLINE (I/O) Analog | | PT 2X2-24AC-ST Order No. 2838283 | + PT 2X2-BE Order No. 2839208 |
|  | PROFIBUS PA Foundation Fieldbus |  | PT 2XEX(I)-24DC-ST Order No. 2838225 | + PT 2XEX(I)-BE Order No. 2839279 |

| | | | | |
|--|--|---|--|--|
|  | Ethernet (incl. PoE) - 100 Base T - 1000 Base T - 10G Base T |  |  | DT-LAN-CAT.6+ Order No. 2881007 |
| | TOKEN Ring VG-AnyLAN | | | |
|  | PROFINET | | | |
|  | ETHERNET - 100 Base T - 1000 Base T |  | DT-LAN-19"-24 Order No. 2838791 | |
| | TOKEN Ring | | DT-LAN-19"-16 Order No. 2880147 | |
| INTERBUS Inline remote bus | |  | DT-UFB-485/BS Order No. 2920612 | |
| | | | DT-UFB-IB-RB0 Order No. 2800056 | |
| | | | DT-UFB-IB-RBI Order No. 2800055 | |



Accessories

| | | |
|--|---|--|
| RJ45 patch cable, length: 0.5 m |  | FL CAT6 PATCH 0,5 Order No. 2891288 |
| RJ45 patch cable, length: 3 m | | FL CAT6 PATCH 3,0 Order No. 2891686 |

High-speed data protection

The DATATRAB family represents effective surge protection for high-speed data transmission.

DT-LAN-CAT.6+ offers universal protection without affecting the signal at network speeds of up to 10 Gbps.

DSL

ADSL, HDSL, VDSL
Analog telephony
ISDN U_{K0}



PT 2-TELE
 Order No. [2882828](#)

ADSL, HDSL, VDSL
Analog telephony
ISDN U_{K0}



DT-TELE-RJ45
 Order No. [2882925](#)

SHDSL

DT-TELE-SHDSL
 Order No. [2801593](#)

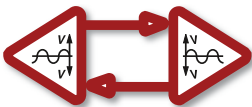

Analog telephony, ADSL, VDSL
 LSA-PLUS technology
 Coarse protection with failsafe contact

CTM 2X1-180DC-GS
 Order No. [2838636](#)

Analog telephony, ADSL, VDSL
 LSA-PLUS technology
 Coarse protection with failsafe contact and
 power cross protection

CTM 2X1-180DC-GS-P
 Order No. [2838623](#)



Analog telephony, ADSL, VDSL
 LSA-PLUS technology
 Coarse protection and fine protection

CTM 1X2-110AC
 Order No. [2838539](#)

Analog telephony, ADSL, VDSL
 LSA-PLUS technology

 Coarse protection



Magazine – CT
 10-2/2-GS/3E-110AC
 Order No. [2920829](#)





ISDN S₀
ISDN S_{2M}
 LSA-PLUS technology



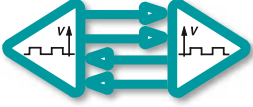

CTM ISDN
 Order No. [2838555](#)

Data technology (serial interfaces)

| | | Plugs | | Base element |
|---|---|---|---|--|
|  | Data systems RS-485 RS-422A |  | PT 5-HF-12DC-ST Order No. 2838775 | + PT 2X2+F-BE Order No. 2839224 |
| | Data systems RS-232C | |  | PT 5-HF-24DC-ST Order No. 2906002 |
|  | RS-485 | | | DT-UFB-485/BS Order No. 2920612 |
| | RS-232 C/V.24 with D-SUB 9 connection | | | DT-UFB-V24/S-9-SB Order No. 2803069 |
| | RS-232 C/V.24 with adapter cable from D-SUB 9 to D-SUB 25 | | | DT-UFB-V24/S-SB-SET Order No. 2803072 |

Accessories

| | | |
|---|---|---|
| Magazine with grounding rail - For accommodating up to 10 CTM plugs |  | CTM 10-MAG Order No. 2838610 |
| Disconnect strip screw terminal block - For NS-32 and NS-35/7.5 DIN rails - Compatible with the CTM 10-MAG with connections for 20 conductors up to 4 mm ² and with break contacts for CTM protective plugs |  | CT-TERMIBLOCK 10 DA Order No. 0441711 |
| LSA-PLUS disconnect strip - For accommodating CTM and CT 10 protection modules - 10 double wires |  | Disconnect strip – CT 10-TL Order No. 2765356 |

Surge protection for transceiver systems

The high frequencies of wireless transmission require the use of protective devices with low insertion loss.

COAXTRAB satisfies this requirement.

The coaxial arresters are suitable for all common transmission systems in mobile communication networks and radio networks used by the authorities, as well as in video or television transmission.

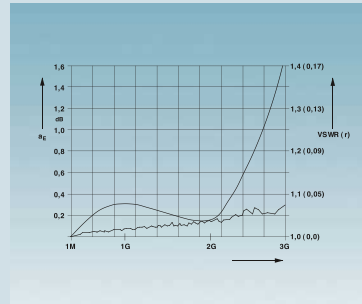

Customized products

Thanks to their very low attenuation values, the surge protective devices ensure interference-free signal transmission in all standard applications.



Shielding

Good shielding properties are vital for clean transmission. Robust metal housings provide the perfect shielding and are suitable for use in harsh environments.



Connection technology

The right connection technology to suit the application: F and N connector, TV connector and 7/16, UHF, BNC connections.



Numerous applications, one solution

Solutions based on the PLUGTRAB series provide the ideal protection for installation in the control cabinet.



Protection for transceiver technology

GSM
UMTS
LTE
WiMAX



GPS or
GSM (900, 1800, 1900 MHz)
UMTS/3G (1.9 ... 2.2 GHz)

- With N connector



CN-UB-280DC-3-BB
Order No. [2801050](#)

CN-UB-280DC-3-SB
Order No. [2801051](#)

GSM (900, 1800, 1900 MHz)
UMTS/3G (1.9 ... 2.2 GHz)

- Without supply voltage on the coaxial cable
- Very low voltage protection level
- With N connector



CN-LAMBDA/4-2.25-BB
Order No. [2801057](#)

CN-LAMBDA/4-2.25-SB
Order No. [2801056](#)

GSM (900, 1800, 1900 MHz)
UMTS/3G (1.9 ... 2.2 GHz)

- Without supply voltage on the coaxial cable
- Very low voltage protection level
- With 7/16 connector



C7/16-LAMBDA/4-2.25-BB
Order No. [2801060](#)

C7/16-LAMBDA/4-2.25-SB
Order No. [2801059](#)

WiMAX (2.4... 6 GHz)
or Industrial Wireless (2.4 GHz)

- Without supply voltage on the coaxial cable
- Very low voltage protection level
- With N connector



CN-LAMBDA/4-5.9-BB
Order No. [2838490](#)

CN-LAMBDA/4-5.9-SB
Order No. [2800023](#)

Accessories

Mounting plate

- For individual fixing of CN-UB-280DC



CN-UB/MP
Order No. [2818135](#)



Mounting plate, angled 90°

- For individual fixing of CN-UB-280DC, e.g., for wall mounting









CN-UB/MP-90DEG-50
Order No. [2803137](#)

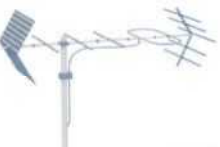

Protection for video monitoring systems

| | | | | |
|---|------------------------------|-----------------------|---|--|
|  | With BNC connection | 50 ohms |  | C-UFB- 5DC/E Order No. 2782300 |
| | | 75 ohms | | C-UFB- 5DC/E 75 Order No. 2763604 |
| | With screw connection | For one video signal |  | PT 3-PB-ST Order No. 2858030 PT 1X2+F-BE Order No. 2856126 |
| | | For two video signals | | PT 2X2-HF- 5DC-ST Order No. 2839567 PT 2X2-BE Order No. 2839208 |

Protection for TV and radio systems

| | | | | |
|---|---|--|---|--|
|  |  | Satellite television Upstream of the distributor (multi-switch) |  | C-SAT-BOX Order No. 2880561 |
| |  | Satellite television Upstream of the SAT receiver or television |  | C-TV-SAT Order No. 2856993 |
|  |  | Cable/terrestrial television Upstream of the television, radio or tuner for the hi-fi system |  | C-TV/HIFI Order No. 2857002 |

Accessories

| | | |
|---|---|---|
| <p>F connector adapter (plug-to-plug)</p> <ul style="list-style-type: none"> - Ideal for directly connecting the C-SAT-BOX to a multi-switch with the same pitch - Threadless plug-in coupling enables fast connection - More secure hold thanks to the clamping ring |  | ADAPTER KOAX TYP F Order No. 2880972 |
| <p>F connector cable (plug-to-plug)</p> <ul style="list-style-type: none"> - For flexibly connecting the C-SAT-BOX to a multi-switch with a different pitch |  | KBL-SAT/20 Order No. 2880985 |

Combined protection for TV and radio connections and the power supply

Satellite television

Used upstream of the SAT receiver or television with simultaneous protection for the power supply.



**MAINTRAB
MNT...**

**Country: DE, AT, NL,
ES, SE**

MNT-TV-SAT D
Order No. [2882284](#)

MNT-TV-SAT D/WH
Order No. [2882297](#)



**Country: BE, FR, CZ,
SK, PL**

MNT-TV-SAT B/F
Order No. [2882307](#)

Cable and terrestrial television

Used upstream of the television, radio or tuner for the hi-fi system with simultaneous protection for the power supply.



**MAINTRAB
MNT...**

**Country: DE, AT, NL,
ES, SE**

MNT-TV-SAT D
Order No. [2882284](#)

MNT-TV-SAT D/WH
Order No. [2882297](#)



**Country: BE, FR, CZ,
SK, PL**

MNT-TV-SAT B/F
Order No. [2882307](#)

CHECKMASTER 2 – The test system for surge protective devices

The CHECKMASTER –

1. Detecting a test object

Lightning protection systems must be tested in accordance with the requirements of IEC 62305-3 and official regulations. Here, a basic visual check is not enough to identify surge protective devices that were previously damaged.

Only an electrical check using the CHECKMASTER 2 produces meaningful results. It automatically checks all relevant components of surge protective devices.



The barcodes on the surge protective devices provide you with a fast, accurate option to enter an item. System-specific abbreviations or user-defined IDs can be entered via the operator interface or read in from the individually created barcode labels. Alternatively, the order number of the test object can be entered via the touch panel.

CHECKMASTER 2
Order No. [2905256](#)

Convenient hand-held scanner

Storage compartment
for an additional test
adapter

Color
LC touch display

Robust case for industrial
environments

USB port

Variable test adapters



2. Inserting a test object



The test object is simply inserted into the associated test adapter and the test is started via the touch panel.

Test adapter for the product ranges:

FLT-CP, FLT-SEC, VAL-CP and VAL-SEC

CM 2-PA-FLT/VAL-CP/SEC
Order No. [2905283](#)

FLT-SEC-H

CM 2-PA-SEC-HYBRID
Order No. [2907889](#)

PT and PLT-SEC (17.5 mm wide)

CM 2-PA-PT/PLT
Order No. [2905284](#)

VAL-MS

CM 2-PA-VAL-MS
Order No. [2905265](#)

CTM

CM 2-PA-CTM
Order No. [2905282](#)

PT 4-PE and PLT-SEC 3S (35 mm wide)

CM 2-PA-PT4/PLT3S
Order No. [2907019](#)

UFBK and UAK

CM 2-PA-PT/A
Order No. [2907891](#)

3. Safe testing



All relevant components of the protective plug are electrically tested in an automatic test process. The results of these tests are shown on a color display:

- **OK:**
The SPD has passed the test.
- **Warning:**
The SPD has reached the tolerance limit – replacement is recommended.
- **Defective:**
The SPD is defective – replacement is required.

4. Save results easily and verifiably



The tests must be documented in accordance with IEC 62305. The CHECKMASTER 2 saves all test results to the internal memory with mains failure protection. The test reports are available via USB stick for convenient further processing in Office programs.

The top features at a glance:

- Convenient, safe and fast testing
- The "Tolerance limit is reached" test status prevents unnecessary service calls
- Automatic log function for test results
- The internal memory also enables subsequent processing of the test results on the computer
- The update function always keeps the CHECKMASTER 2 up-to-date with the latest developments (item database, firmware, language files)
- A high level of investment security thanks to variable test adapters
- Increased system availability, thanks to screening test
- IEC 62305-3-compliant testing

LM-S lightning monitoring system – Optimum maintenance planning

LM-S is the live monitoring system for the continuous detection and evaluation of lightning strikes. It detects and analyzes all the important parameters associated with lightning surge currents. This allows you to assess the actual load of the system. Based on this information, you can determine whether any checks or maintenance are required.

Additional areas of use are buildings, telecommunication technology, high and extra-high voltage technology, transportation technology and industrial settings.

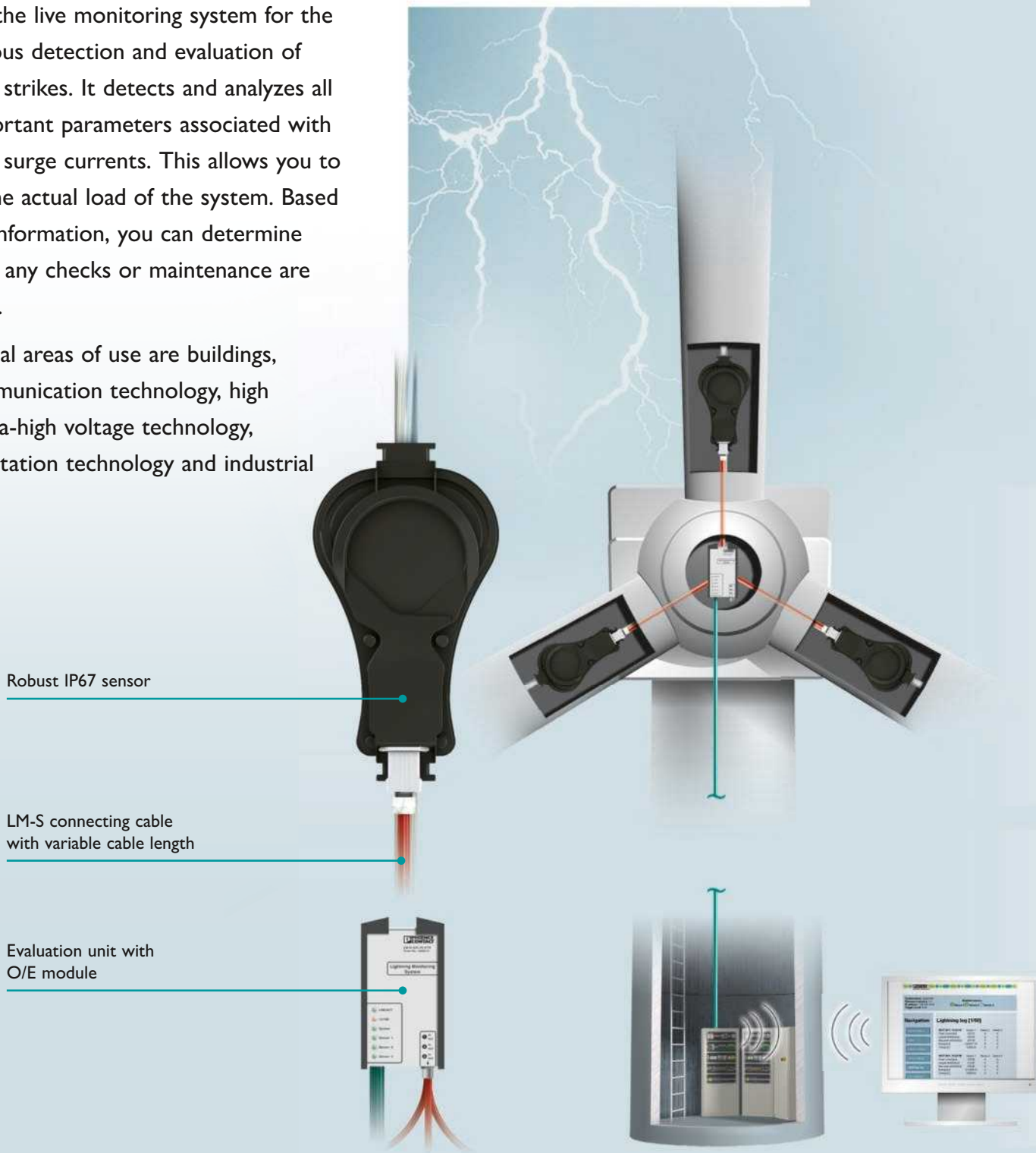

Faraday effect as a reliable measuring method

The internal measuring principle of the LM-S is based on the Faraday effect. Polarized light in a specific medium is rotated through a magnetic field over a defined length and measured.

The lightning monitoring system detects this change in the light signal and uses it as the basis for obtaining the measured value results.

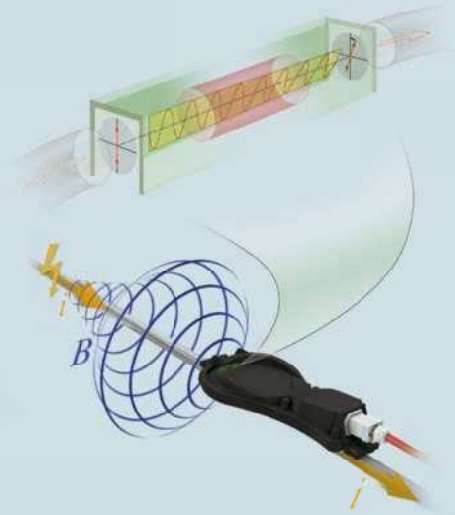

A complete measuring system application consists of a maximum of three sensors, fiber optic cables and the analysis module. A sensor is installed on each of the lightning arresters on an object. Fiber optics connect the sensors to the O/E converter on the analysis module.

Acquisition and evaluation

The sensors are mounted on the lightning current arrester cables. They record the magnetic field that occurs around the conductor due to the lightning surge current. The measured result is transmitted via fiber optics to the O/E module of the evaluation unit, where the optical signal is converted into an electrical signal. Based on the values obtained, the evaluation unit determines the lightning characteristics with their typical parameters, such as the maximum lightning current strength, lightning current rate of rise, charge and energy.

Remote monitoring in real time

The evaluation unit can be easily integrated into standard network systems via the RJ45 Ethernet interface. Access to the data acquired as well as configuration of the system is via an internal web server.

Using standard network technologies enables flexible system integration and offers users a wide range of options for using existing management or remote control systems.



Evaluation unit:
LM-S-A/C-3S-ETH
Order No. [2800618](#)



Sensor:
LM-S-LS-H
Order No. [2800616](#)



Connecting lines:
Suitable connecting lines on request.



O/E module:
LM-S-C-3LS
Order No. [2800617](#)

Mains interference filters for power supplies and measurement signals

Interference suppression filters limit conductive, high-frequency interference voltages. Devices used in data processing or automation particularly benefit from a clean power supply.

The end result is safe operation and reliable measured results.

Reliable signals with mains interference filters

Switching operations triggered mechanically or electronically generate pulse-like and high-frequency interference voltages. These voltages spread in an unimpeded manner across the cable network. All the devices within this cable network are affected. Data errors, uncontrolled functions and system crashes can result, with data-processing devices at particular risk.

Mains interference filters – operating principle and range

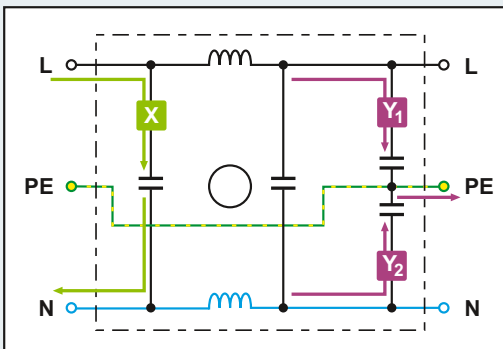

Operating principle of filter circuits

Filtering of symmetrical disturbance variables

X Interference voltages between the phase and neutral conductor are filtered.

Filtering of asymmetrical disturbance variables

Y₁ The opposite grounded interference voltages from phase to PE and from the neutral conductor to PE are filtered.
Y₂

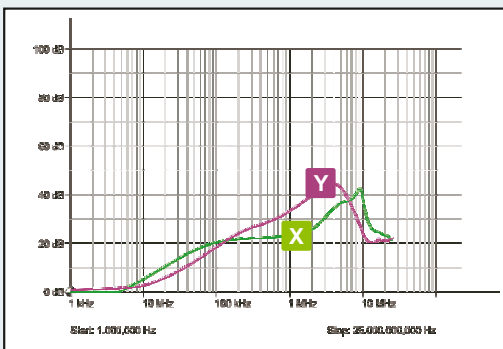

Operating range of filters

An attenuation curve diagram illustrates the effective range of mains interference filters. The relevant frequency-dependent attenuation can be read according to the symmetrical or asymmetrical filter circuit.

Mains interference filters with 1 to 10 A rated load current

FILTRAB devices are mains interference filters for single-phase circuits and limit both asymmetrical and symmetrical interference voltages. As with all filter devices, ideally they should be installed directly upstream of the device requiring protection.



■ **a_E symmetrical:** ≥ 65 dB (1 MHz/50 Ω)
■ **a_E asymmetrical:** ≥ 45 dB (1 MHz/50 Ω)

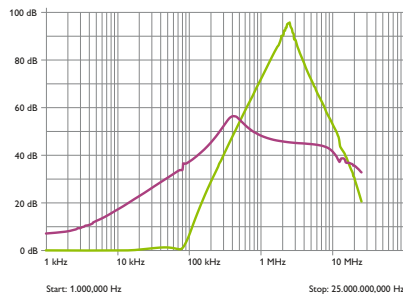

■ **a_E symmetrical:** ≥ 55 dB (1 MHz/50 Ω)
■ **a_E asymmetrical:** ≥ 35 dB (1 MHz/50 Ω)

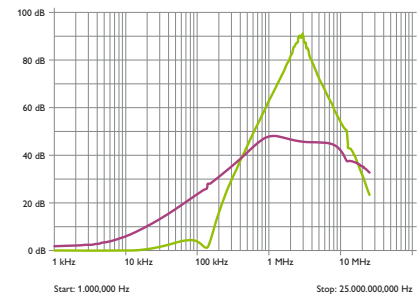

FILTRAB

NEF 1-1
Order No. [2794123](#)

NEF 1-3
Order No. [2794110](#)

Nominal voltage U_N

240 V AC

240 V AC

Rated frequency f_N

50 Hz | 60 Hz

50 Hz | 60 Hz

Rated load current I_L

1 A (≤ 40 °C)

3 A (≤ 40 °C)

Backup fuse max. in accordance with IEC

1 A (gL)

3 A (gL)

Test standards

IEC 60939-2 | EN 60939-2

IEC 60939-2 | EN 60939-2



■ **a_E symmetrical:** ≥ 80 dB (1 MHz/50 Ω)
■ **a_E asymmetrical:** ≥ 40 dB (1 MHz/50 Ω)

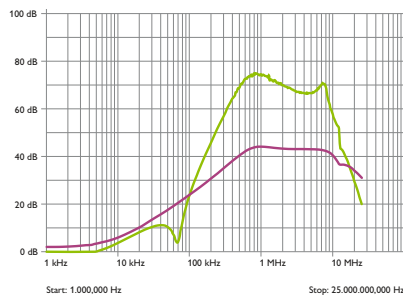

■ **a_E symmetrical:** ≥ 55 dB (1 MHz/50 Ω)
■ **a_E asymmetrical:** ≥ 35 dB (1 MHz/50 Ω)

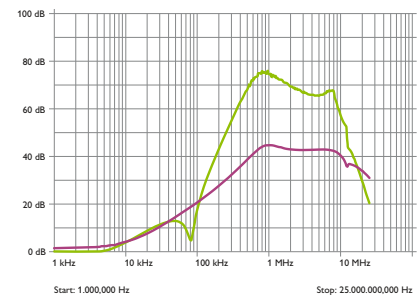

FILTRAB

NEF 1-6
Order No. [2783082](#)

NEF 1-10
Order No. [2788977](#)

Nominal voltage U_N

240 V AC

240 V AC

Rated frequency f_N

50 Hz | 60 Hz

50 Hz | 60 Hz

Rated load current I_L

6 A (≤ 40 °C)

10 A (≤ 40 °C)

Backup fuse max. in accordance with IEC

6.3 A (gL)

10 A (gL)

Test standards

IEC 60939-2 | EN 60939-2

IEC 60939-2 | EN 60939-2

Combined mains interference filters with type 3 surge protection

SFP – SURGE FILTER PROTECTION

Rail-mountable mains interference filter with integrated device protection (type 3), optical status indicator and floating remote indication contact.



With floating remote indication contact

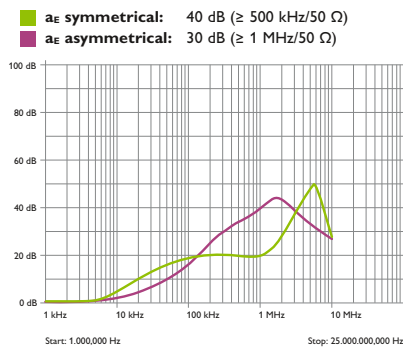

| SURGE FILTER PROTECTION | SFP 1-5/120AC Order No. 2920667 | SFP 1-10/120AC Order No. 2920670 | SFP 1-15/120AC Order No. 2920683 | SFP 1-20/120AC Order No. 2856702 |
|--|---|-------------------------------------|-------------------------------------|-------------------------------------|
| Nominal voltage U_N Phases | 120 V AC 1-phase | | | |
| Rated load current I_L | 5 A (70 °C) | 10 A (60 °C) | 15 A (50 °C) | 20 A (40 °C) |
| Rated frequency f_N | 50 Hz 60 Hz | | | |
| Nominal discharge current I_n (8/20) μ s | 3 kA (L-N) 3 kA (L-PE) | | | |
| Voltage protection level U_p | ≤ 450 V (L-N) ≤ 450 V (L(N)-PE) | | | |
| Backup fuse max. in accordance with IEC | 20 A (gL gG) | | | |
| IEC test classifications EN types | III T3 | | | |
| IEC 61643-11 EN 61643-11 UL 1449 | • • • | | | • • • |

| SURGE FILTER PROTECTION | SFP 1-20/230AC Order No. 2859987 | ■ a_E symmetrical: 20 dB (≥ 100 kHz/50 Ω) ■ a_E asymmetrical: 30 dB (≥ 1 MHz/50 Ω) |
|--|---|--|
| Nominal voltage U_N Phases | 230 V AC 1-phase | <p>Start: 1.000.000 Hz Stop: 25.000.000.000 Hz</p> |
| Rated load current I_L | 20 A (40 °C) | |
| Rated frequency f_N | 50 Hz 60 Hz | |
| Nominal discharge current I_n (8/20) μ s | 5 kA (L-N) 5 kA (L-PE) | |
| Voltage protection level U_p | ≤ 1 kV (L-N) ≤ 1 kV (L(N)-PE) | |
| Backup fuse max. in accordance with IEC | 20 A (gL gG) | |
| IEC test classifications EN types | III T3 | |
| IEC 61643-11 EN 61643-11 UL 1449 | • • – | |

TERMITRAB

Combination of mains interference filter and surge protection for two signal wires with a shared reference potential.

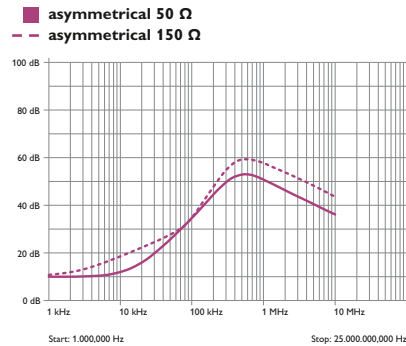
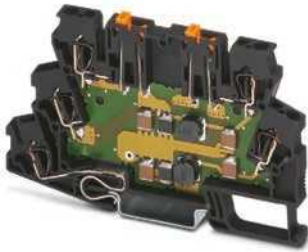

TERMITRAB

TT-ST-M-SFP-24AC
Order No. [2858946](#)

TT-D-STTCO-BK
Order No. [2858894](#)

| | |
|--|---|
| Nominal voltage U_N Phases | 24 V AC |
| Rated frequency f_N | 50 Hz 60 Hz |
| Rated load current I_L | 500 mA ($\leq 55^\circ\text{C}$) |
| Nominal discharge current I_n (8/20) μs | 350 A (L-PE) |
| Voltage protection level U_p | ≤ 80 V (C1 (500 V / 250 A)) (L-PE) |
| Backup fuse max. in accordance with IEC | 500 mA (e.g. T acc. to 127-2/III) |
| IEC test classifications EN types | C1 C3 |
| Test standards | IEC 61643-21, EN 61643-21 |

Accessories:

Cover for terminating a row of terminal blocks



Always up-to-date, always available to you. Here you'll find everything on our products, solutions and service:

phoenixcontact.com

Product range

- Cables and wires
- Connectors
- Controllers
- Electronics housings
- Electronic switchgear and motor control
- Fieldbus components and systems
- Functional safety
- HMIs and industrial PCs
- I/O systems
- Industrial communication technology
- Industrial Ethernet
- Installation and mounting material
- Lighting and signaling
- Marking and labeling
- Measurement and control technology
- Modular terminal blocks
- Monitoring
- PCB terminal blocks and PCB connectors
- Power supply units and UPS
- Protective devices
- Relay modules
- Sensor/actuator cabling
- Software
- Surge protection and interference filters
- System cabling for controllers
- Tools
- Wireless data communication

PHOENIX CONTACT GmbH & Co. KG
Flachsmarktstraße 8
32825 Blomberg, Germany
Phone: + 49 5235 3-00
Fax: + 49 5235 3-41200
E-mail: info@phoenixcontact.com
phoenixcontact.com