

DATE	SYM	REVISION	RECORD	AUTH	DR	CK

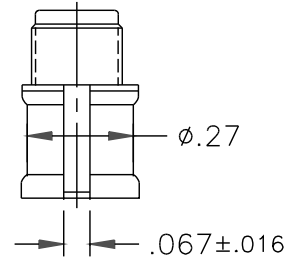
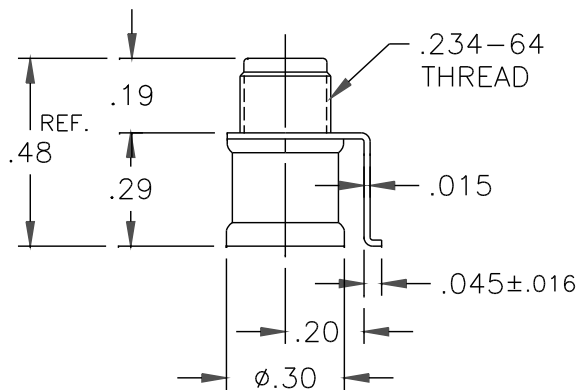
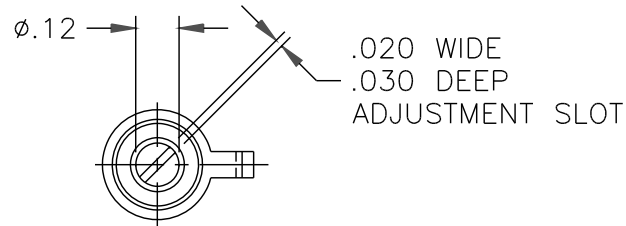

NOTES:

1. CAPACITANCE RANGE, pF: 1.0 TO 23.0
2. DC WORKING VOLTAGE AT 23.0 pF: 750 VDC.
3. DC WITHSTANDING VOLTAGE AT 23.0 pF: 1500 VDC.
4. Q FACTOR AT 100 MHz AND 23.0 pF: 2000 MIN
5. INSULATION RESISTANCE: 10^6 MEGOHMS AT 25°C
6. TEMPERATURE COEFFICIENT: 50 ± 50 PPM/°C.
7. OPERATING TEMPERATURE: -65°C TO +125°C
8. TUNING TORQUE: 0.5 TO 5.0 IN-OZ
9. ROTATIONAL LIFE: 600 TURNS
10. VIBRATION: 50g AT 10-2000 Hz
11. SHOCK: 1500g, 0.5 MILLISECS.
12. SEAL: 40 PSI

TOLERANCES (EXCEPT AS NOTED)	VOLTRONICS CORPORATION 100 FORD RD. DENVER N.J.		
DECIMAL XXX ±.005 XX ±.016	SCALE 2 : 1	DRAWN BY A.SHTABNAYA	
FRACTIONAL -	TITLE OUTLINE DWG. AM25HV	APPROVED BY A.GOLDBERG	
ANGULAR -	DATE 8/18/09	DRAWING NUMBER 70,567	