

PRECISION 5.0 VOLT LOW KNEE CURRENT VOLTAGE REFERENCE

ZRC500

ISSUE 3 - MARCH 1998

DEVICE DESCRIPTION

The ZRC500 uses a bandgap circuit design to achieve a precision micropower voltage reference of 5.0 volts. The device is available in small outline surface mount packages, ideal for applications where space saving is important, as well as packages for through hole requirements.

The ZRC500 design provides a stable voltage without an external capacitor and is stable with capacitive loads. The ZRC500 is recommended for operation between 25 μ A and 5mA and so is ideally suited to low power and battery powered applications.

Excellent performance is maintained to an absolute maximum of 25mA, however the rugged design and 20 volt processing allows the reference to withstand transient effects and currents up to 200mA. Superior switching capability allows the device to reach stable operating conditions in only a few microseconds.

FEATURES

- Small outline SOT23, SO8 and TO92 style packages
- No stabilising capacitor required
- Low knee current, 19 μ A typical
- Typical T_C 30ppm/ $^{\circ}$ C
- Typical slope resistance 0.4 Ω
- \pm 3%, 2% and 1% tolerance
- Industrial temperature range
- Operating current 25 μ A to 5mA
- Transient response, stable in less than 10 μ s
- Optional extended current range

APPLICATIONS

- Battery powered and portable equipment.
- Instrumentation.
- Test equipment.
- Metering and measurement systems.

SCHEMATIC DIAGRAM

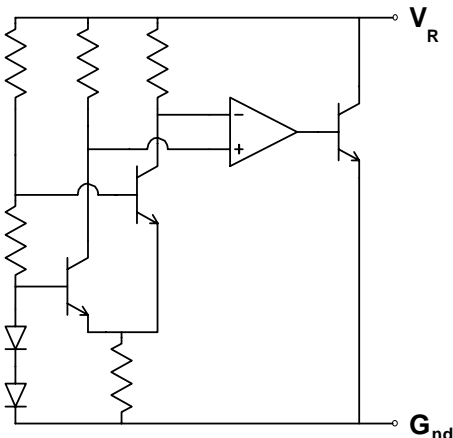

ZRC500

ABSOLUTE MAXIMUM RATING

Reverse Current	25mA
Forward Current	25mA
Operating Temperature	-40 to 85°C
Storage Temperature	-55 to 125°C

Power Dissipation (T_{amb}=25°C)

SOT23	330mW
E-Line, 3 pin (TO92)	500mW
E-Line, 2 pin (TO92)	500mW
SO8	625mW

ELECTRICAL CHARACTERISTICS

TEST CONDITIONS (Unless otherwise stated) T_{amb}=25°C

SYMBOL	PARAMETER	CONDITIONS	LIMITS			TOL. %	UNITS
			MIN	TYP	MAX		
V _R	Reverse Breakdown Voltage	I _R =150μA	4.95 4.9 4.85	5.0 5.0 5.0	5.05 5.1 5.15	1 2 3	V
I _{MIN}	Minimum Operating Current			19	25		μA
I _R	Recommended Operating Current		0.025		5		mA
T _C †	Average Reverse Breakdown Voltage Temp. Co.	I _{R(min)} to I _{R(max)}		30	90		ppm/°C
R _S §	Slope Resistance			0.4	2		Ω
Z _R	Reverse Dynamic Impedance	I _R = 1mA f = 100Hz I _{AC} =0.1 I _R		0.3	0.8		Ω
E _N	Wideband Noise Voltage	I _R = 150μA f = 10Hz to 10kHz		105			μV(rms)

$$\dagger T_C = \frac{(V_{R(max)} - V_{R(min)}) \times 1000000}{V_R \times (T_{(max)} - T_{(min)})}$$

Note: V_{R(max)} - V_{R(min)} is the maximum deviation in reference voltage measured over the full operating temperature range.

$$\S R_S = \frac{V_R \text{ Change}(I_{R(min)} \text{ to } I_{R(max)})}{I_{R(max)} - I_{R(min)}}$$

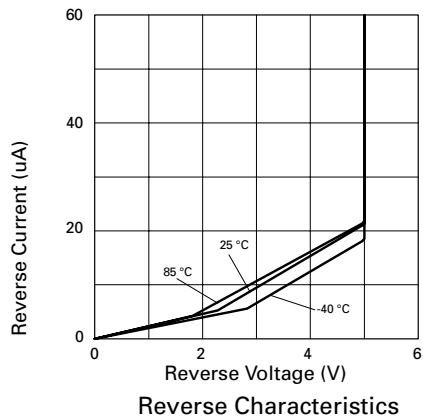

ZRC500

TYPICAL CHARACTERISTICS

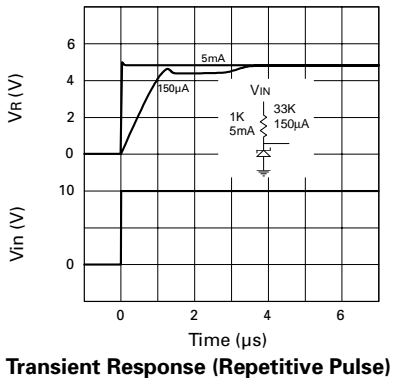
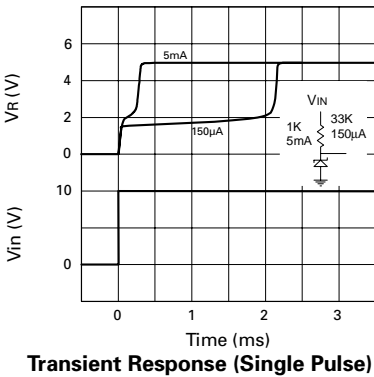
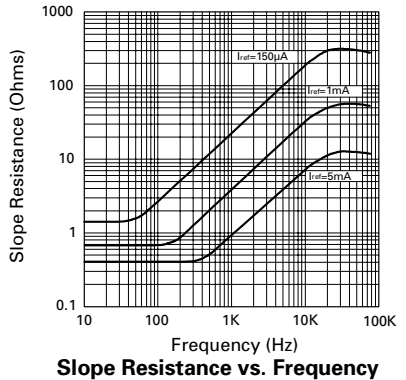
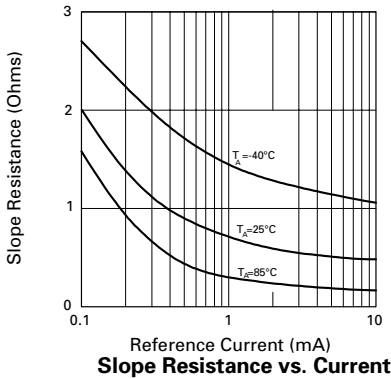
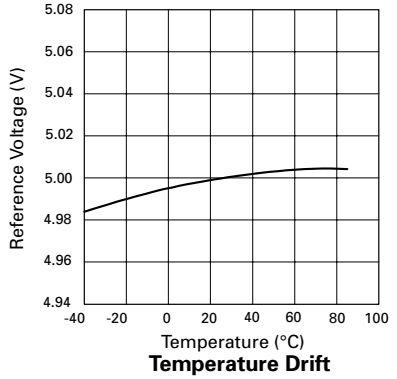
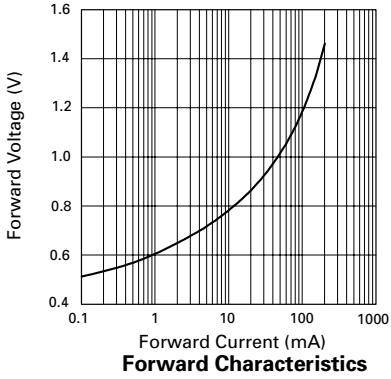

ZRC500

CONNECTION DIAGRAMS

E-Line, 2 pin Package Suffix - Y

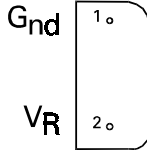

Bottom View

E-Line, 3 pin, Rev Package Suffix - R

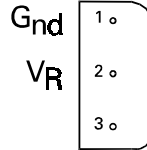

Bottom View -
Pin 3 floating or connected to pin 1

E-Line, 3 pin Package Suffix - A

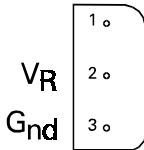

Bottom View -
Pin 1 floating or connected to pin 3

SO8 Package Suffix - N8

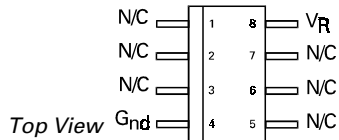

Top View

SOT23 Package Suffix - F

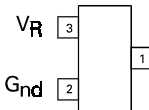

Top View -
Pin 1 floating or connected to pin 2

ZRC500

ORDERING INFORMATION

Part No	Tol%	Package	Partmark
ZRC500A03	3	E-Line •	ZRC50003
ZRC500A02	2	E-Line •	ZRC50002
ZRC500A01	1	E-Line •	ZRC50001
ZRC500F03	3	SOT23	50P
ZRC500F02	2	SOT23	50T
ZRC500F01	1	SOT23	50X
ZRC500N803	3	SO8	ZRC50003
ZRC500N802	2	SO8	ZRC50002
ZRC500N801	1	SO8	ZRC50001

Part No	Tol%	Package	Partmark
ZRC500R03	3	E-Line *	ZRC500R3
ZRC500R02	2	E-Line *	ZRC500R2
ZRC500R01	1	E-Line *	ZRC500R1
ZRC500Y03	3	E-Line †	ZRC50003
ZRC500Y02	2	E-Line †	ZRC50002
ZRC500Y01	1	E-Line †	ZRC50001

* E-Line 3 pin Reversed

† E-Line 2 pin

• E-Line 3 pin