

MBR3045ST, MBRB3045CT-1

SWITCHMODE™ Power Rectifier

Features and Benefits

- Dual Diode Construction — Terminals 1 and 3 May Be Connected for Parallel Operation at Full Rating
- 45 V Blocking Voltage
- Low Forward Voltage Drop
- 175°C Operating Junction Temperature
- Pb-Free Packages are Available

Applications

- Power Supply – Output Rectification
- Power Management
- Instrumentation

Mechanical Characteristics

- Case: Epoxy, Molded
- Weight (Approximately): 1.9 Grams (TO-220AB)
1.5 Grams (TO-262)
- Finish: All External Surfaces Corrosion Resistant and Terminal Leads are Readily Solderable
- Lead Temperature for Soldering Purposes:
260°C Max. for 10 Seconds
- Epoxy Meets UL 94 V-0 @ 0.125 in

MAXIMUM RATINGS

Rating	Symbol	Value	Unit
Peak Repetitive Reverse Voltage Working Peak Reverse Voltage DC Blocking Voltage	V_{RRM} V_{RWM} V_R	45	V
Average Rectified Current ($T_C = 130^\circ\text{C}$)	Per Device Per Diode $I_{F(AV)}$	30 15	A
Peak Repetitive Forward Current, per Diode (Square Wave, $V_R = 45\text{ V}$, 20 kHz)	I_{FRM}	30	A
Non-Repetitive Peak Surge Current (Surge Applied at Rated Load Conditions, Halfwave, Single Phase, 60 Hz)	I_{FSM}	150	A
Peak Repetitive Reverse Current, per Diode (2.0 μs , 1.0 kHz)	I_{RRM}	2.0	A
Storage Temperature Range	T_{stg}	-65 to +175	°C
Operating Junction Temperature (Note 1)	T_J	-65 to +175	°C
Peak Surge Junction Temperature (Forward Current Applied)	$T_{J(pk)}$	175	°C
Voltage Rate of Change (Rated V_R)	dv/dt	10,000	V/ μs

Stresses exceeding Maximum Ratings may damage the device. Maximum Ratings are stress ratings only. Functional operation above the Recommended Operating Conditions is not implied. Extended exposure to stresses above the Recommended Operating Conditions may affect device reliability.

1. The heat generated must be less than the thermal conductivity from Junction-to-Ambient: $dP_D/dT_J < 1/R_{\theta JA}$.



ON Semiconductor™

<http://onsemi.com>

SCHOTTKY BARRIER RECTIFIER 30 AMPERES 45 VOLTS

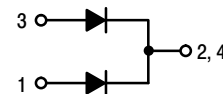

MARKING DIAGRAMS

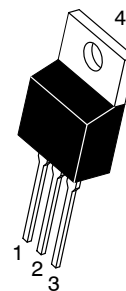

TO-220AB
CASE 221A
STYLE 6

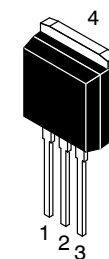

I²PAK (TO-262)
CASE 418D
PLASTIC



A = Assembly Location
Y = Year
WW = Work Week
AKA = Polarity Designator
G = Pb-Free Device

ORDERING INFORMATION

See detailed ordering and shipping information in the package dimensions section on page 3 of this data sheet.

MBR3045ST, MBRB3045CT-1

THERMAL CHARACTERISTICS (Per Diode)

Characteristic	Symbol	Value	Unit
Thermal Resistance, Junction to Case	$R_{\theta JC}$	1.5	$^{\circ}C/W$

ELECTRICAL CHARACTERISTICS (Per Diode)

Instantaneous Forward Voltage (Note 2)	($i_F = 15$ Amp, $T_C = 25^{\circ}C$)	v_F	0.62	Volts
	($i_F = 15$ Amp, $T_C = 125^{\circ}C$)		0.57	
	($i_F = 30$ Amp, $T_C = 25^{\circ}C$)		0.76	
	($i_F = 30$ Amp, $T_C = 125^{\circ}C$)		0.72	
Instantaneous Reverse Current (Note 2)	($V_R = 45$ Volts, $T_C = 25^{\circ}C$)	I_R	0.2	mA
	($V_R = 45$ Volts, $T_C = 125^{\circ}C$)		40	

2 Pulse Test: Pulse Width = 300 μs , Duty Cycle $\leq 2.0\%$

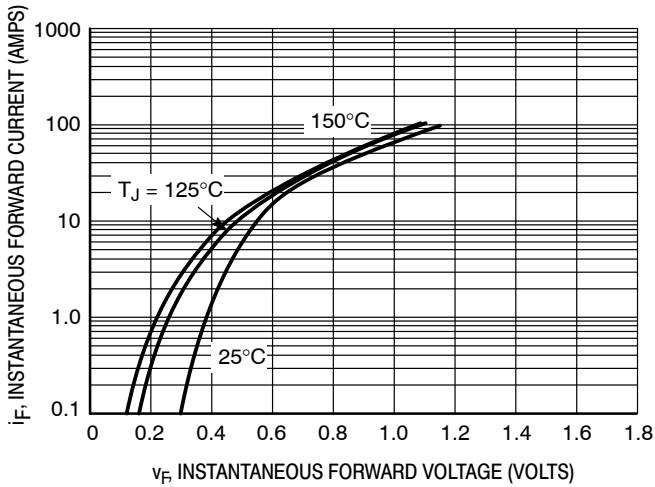

Figure 1. Typical Forward Voltage

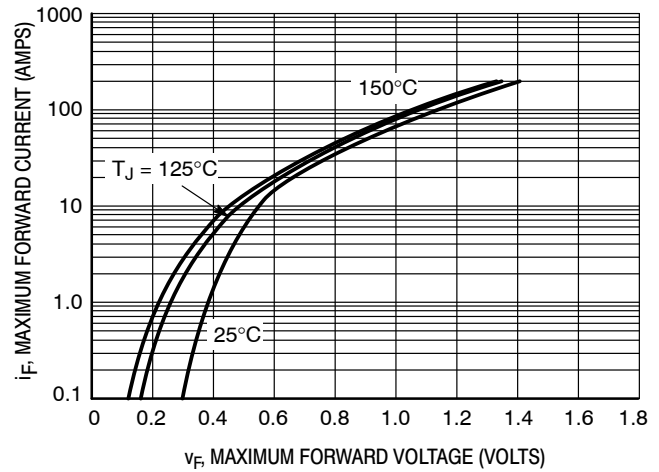

Figure 2. Maximum Reverse Current

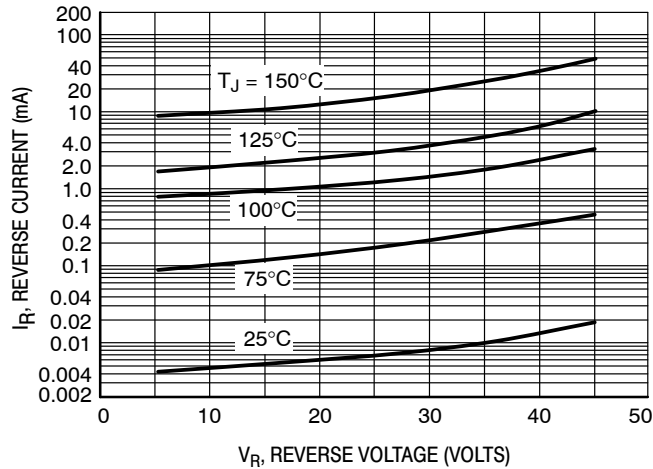

Figure 3. Typical Reverse Current

MBR3045ST, MBRB3045CT-1

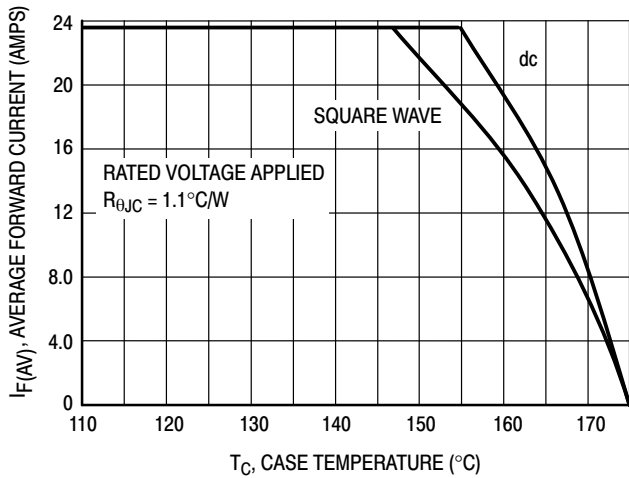

Figure 4. Current Derating, Case

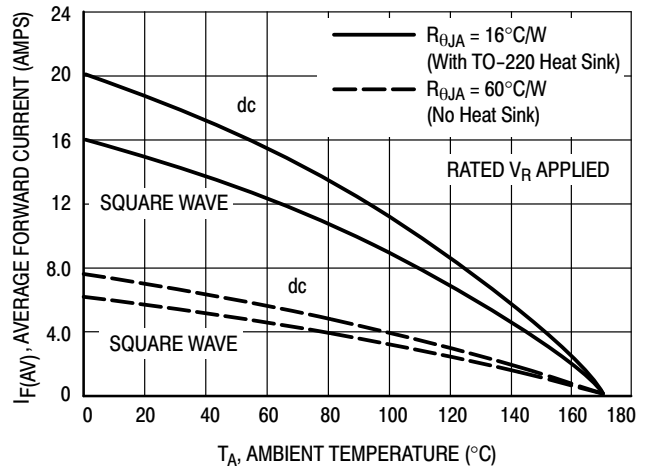

Figure 5. Current Derating, Ambient

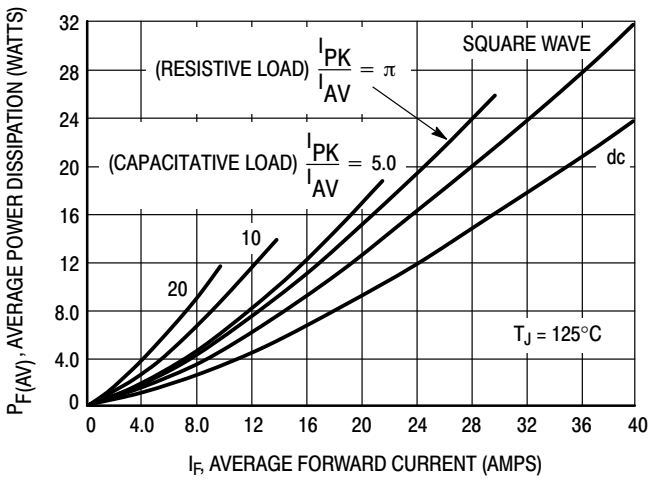

Figure 6. Forward Power Dissipation

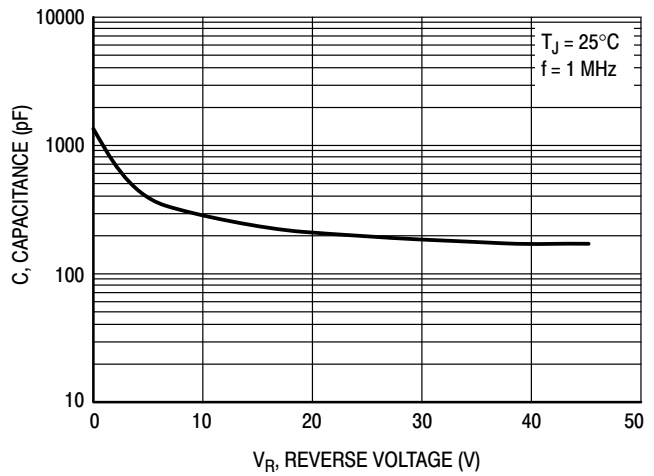

Figure 7. Capacitance

ORDERING INFORMATION

Device	Package	Shipping
MBR3045ST	TO-220	50 Units/Rail
MBR3045STG	TO-220 (Pb-Free)	50 Units/Rail
MBRB3045CT-1	TO-262	50 Units/Rail
MBRB3045CT-1G	TO-262 (Pb-Free)	50 Units/Rail

MBR3045ST, MBRB3045CT-1

PACKAGE DIMENSIONS

TO-220
CASE 221A-09
ISSUE AF

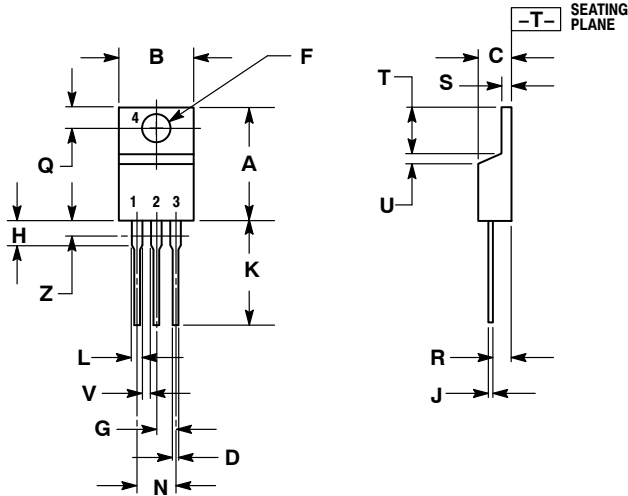

NOTES:

1. DIMENSIONING AND TOLERANCING PER ANSI Y14.5M, 1982.
2. CONTROLLING DIMENSION: INCH.
3. DIMENSION Z DEFINES A ZONE WHERE ALL BODY AND LEAD IRREGULARITIES ARE ALLOWED.

DIM	INCHES		MILLIMETERS	
	MIN	MAX	MIN	MAX
A	0.570	0.620	14.48	15.75
B	0.380	0.405	9.66	10.28
C	0.160	0.190	4.07	4.82
D	0.025	0.035	0.64	0.88
F	0.142	0.161	3.61	4.09
G	0.095	0.105	2.42	2.66
H	0.110	0.155	2.80	3.93
J	0.014	0.025	0.36	0.64
K	0.500	0.562	12.70	14.27
L	0.045	0.060	1.15	1.52
N	0.190	0.210	4.83	5.33
Q	0.100	0.120	2.54	3.04
R	0.080	0.110	2.04	2.79
S	0.045	0.055	1.15	1.39
T	0.235	0.255	5.97	6.47
U	0.000	0.050	0.00	1.27
V	0.045	---	1.15	---
Z	---	0.080	---	2.04

STYLE 6:

- PIN 1. ANODE
- CATHODE
- ANODE
- CATHODE

MBR3045ST, MBRB3045CT-1

PACKAGE DIMENSIONS

I²PAK (TO-262)
CASE 418D-01
ISSUE D

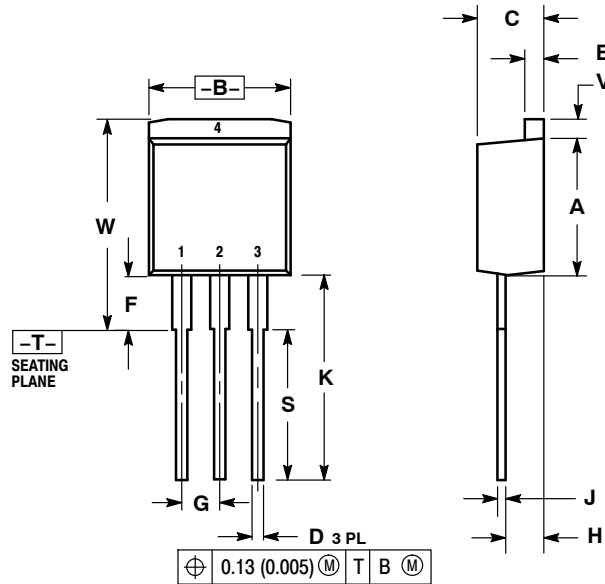

- NOTES:
1. DIMENSIONING AND TOLERANCING PER ANSI Y14.5M, 1982.
2. CONTROLLING DIMENSION: INCH.

DIM	INCHES		MILLIMETERS	
	MIN	MAX	MIN	MAX
A	0.335	0.380	8.51	9.65
B	0.380	0.406	9.65	10.31
C	0.160	0.185	4.06	4.70
D	0.026	0.035	0.66	0.89
E	0.045	0.055	1.14	1.40
F	0.122 REF		3.10 REF	
G	0.100 BSC		2.54 BSC	
H	0.094	0.110	2.39	2.79
J	0.013	0.025	0.33	0.64
K	0.500	0.562	12.70	14.27
S	0.390 REF		9.90 REF	
V	0.045	0.070	1.14	1.78
W	0.522	0.551	13.25	14.00

SWITCHMODE is a trademark of Semiconductor Components Industries, LLC.

ON Semiconductor and are registered trademarks of Semiconductor Components Industries, LLC (SCILLC). SCILLC reserves the right to make changes without further notice to any products herein. SCILLC makes no warranty, representation or guarantee regarding the suitability of its products for any particular purpose, nor does SCILLC assume any liability arising out of the application or use of any product or circuit, and specifically disclaims any and all liability, including without limitation special, consequential or incidental damages. "Typical" parameters which may be provided in SCILLC data sheets and/or specifications can and do vary in different applications and actual performance may vary over time. All operating parameters, including "Typicals" must be validated for each customer application by customer's technical experts. SCILLC does not convey any license under its patent rights nor the rights of others. SCILLC products are not designed, intended, or authorized for use as components in systems intended for surgical implant into the body, or other applications intended to support or sustain life, or for any other application in which the failure of the SCILLC product could create a situation where personal injury or death may occur. Should Buyer purchase or use SCILLC products for any such unintended or unauthorized application, Buyer shall indemnify and hold SCILLC and its officers, employees, subsidiaries, affiliates, and distributors harmless against all claims, costs, damages, and expenses, and reasonable attorney fees arising out of, directly or indirectly, any claim of personal injury or death associated with such unintended or unauthorized use, even if such claim alleges that SCILLC was negligent regarding the design or manufacture of the part. SCILLC is an Equal Opportunity/Affirmative Action Employer. This literature is subject to all applicable copyright laws and is not for resale in any manner.

PUBLICATION ORDERING INFORMATION

LITERATURE FULFILLMENT:
Literature Distribution Center for ON Semiconductor
P.O. Box 5163, Denver, Colorado 80217 USA
Phone: 303-675-2175 or 800-344-3860 Toll Free USA/Canada
Fax: 303-675-2176 or 800-344-3867 Toll Free USA/Canada
Email: orderlit@onsemi.com

N. American Technical Support: 800-282-9855 Toll Free
USA/Canada
Europe, Middle East and Africa Technical Support:
Phone: 421 33 790 2910
Japan Customer Focus Center
Phone: 81-3-5773-3850

ON Semiconductor Website: www.onsemi.com
Order Literature: <http://www.onsemi.com/orderlit>
For additional information, please contact your local
Sales Representative