

CDBA120-G Thru. CDBA1100-G

Reverse Voltage: 20 to 100 Volts

Forward Current: 1.0 Amp

RoHS Device

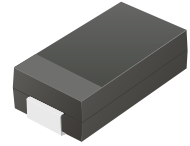

Features

- Ideal for surface mount applications.
- Easy pick and place.
- Plastic package has Underwriters Lab. flammability classification 94V-0.
- Built-in strain relief.
- Low forward voltage drop.

Mechanical data

- Case: JEDEC DO-214AC, molded plastic.
- Terminals: solderable per MIL-STD-750, method 2026.
- Polarity: Color band denotes cathode end.
- Approx. weight: 0.064 grams

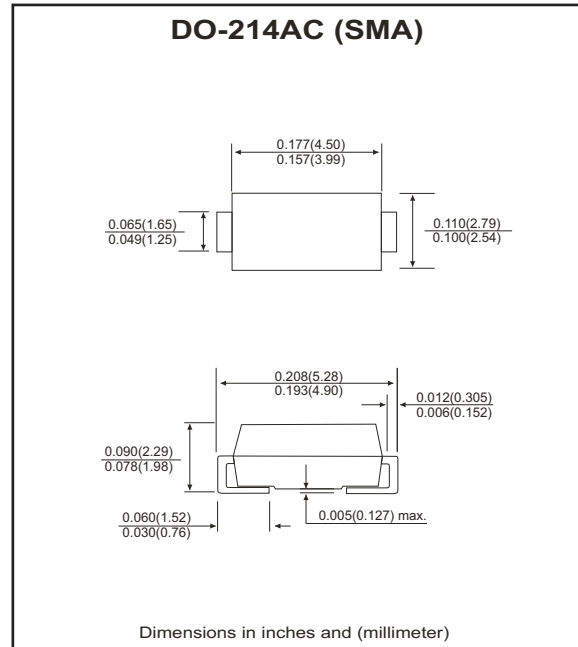

Maximum Ratings and Electrical Characteristics

Parameter	Symbol	CDBA 120-G	CDBA 140-G	CDBA 160-G	CDBA 180-G	CDBA 1100-G	Units
Max. repetitive peak reverse voltage	V_{RRM}	20	40	60	80	100	V
Max. DC blocking voltage	V_{DC}	20	40	60	80	100	V
Max. RMS voltage	V_{RMS}	14	28	42	56	70	V
Peak forward surge current, 8.3ms single half sine-wave superimposed on rate load (JEDEC Method)	I_{FSM}	30					A
Max. average forward rectified current 0.375" (9.5mm) lead length(see fig.1)	$I_{(AV)}$	1.0					A
Max. instantaneous forward voltage at 1.0A(Note 1)	V_F	0.55		0.75		0.85	V
Max. instantaneous reverse current at rated DC blocking voltage(Note 1)	$T_A=25\text{ }^\circ\text{C}$	I_R	0.5				mA
	$T_A=125\text{ }^\circ\text{C}$		10				
Max. thermal resistance (Note 2)	$R_{\theta JA}$	88					$^\circ\text{C/W}$
	$R_{\theta JL}$	28					
Operating and storage temperature Range	T_J	-65 to +125		-65 to +150			$^\circ\text{C}$
Storage temperature range	T_{STG}	-65 to +150					$^\circ\text{C}$

Notes:

1. P.C.B. Mounted with 0.2x0.2 inch (5.0*5.0mm) copper pad .
2. Pulse test: 300 μ s width, 1% duty cycle.

RATING AND CHARACTERISTIC CURVES (CDBA120-G thru CDBA1100-G)

Fig.1 - Forward Current Derating Curve

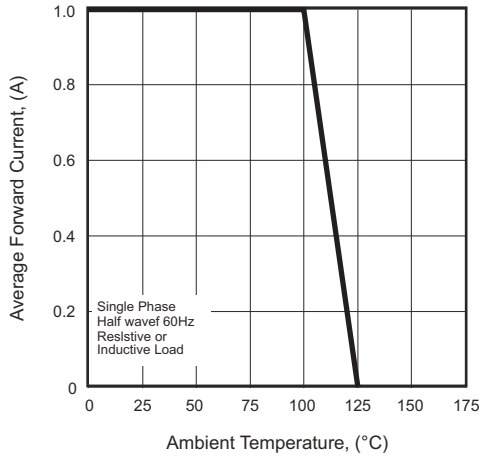

Fig.2 - MAXMUM Non-Repetitive Surge Current

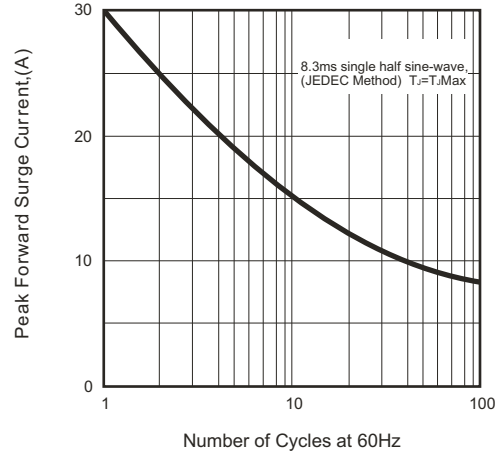

Fig.3 - Forward Characteristics

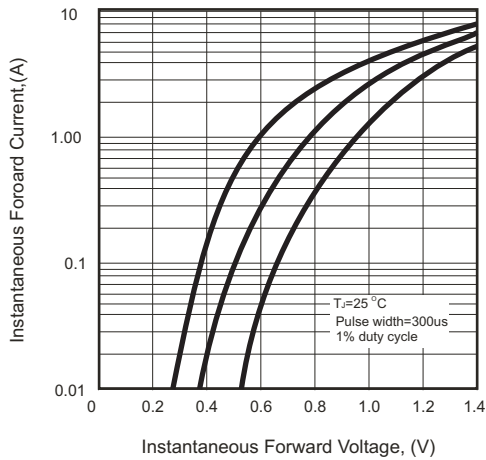

Fig.4 - Typical Junction Capacitance

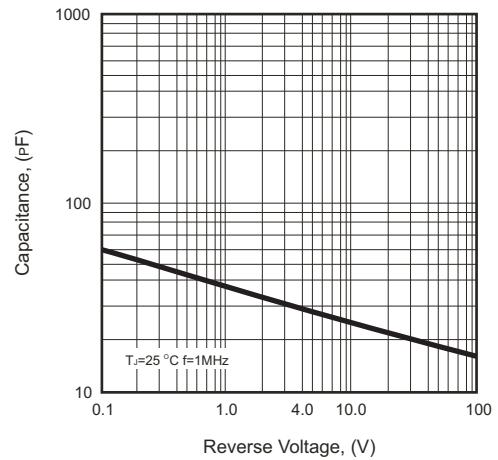
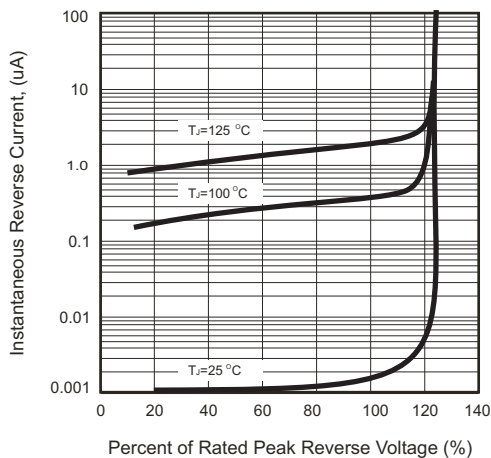
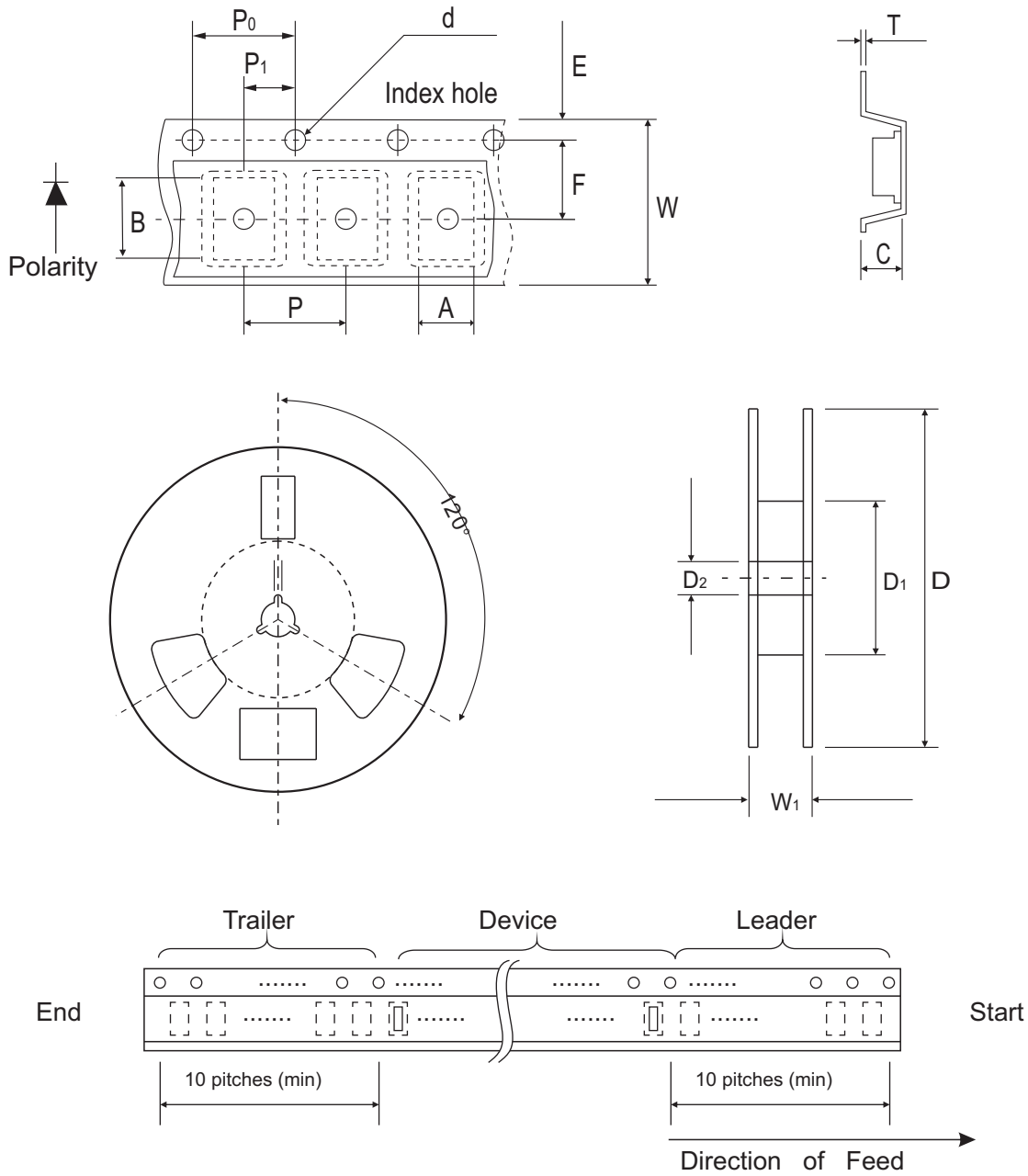

Fig.5 - Typical Reverse Characteristics



Reel Taping Specification



SMA (DO-214AC)	SYMBOL	A	B	C	d	D	D1	D2
	(mm)	2.70 (max)	5.30 (max)	2.66 (max)	1.50 ± 0.10	330 ± 2.00	50.0 MIN.	13.5 ± 1.00
	(inch)	0.106 (max)	0.209 (max)	0.105 (max)	0.059 ± 0.004	12.99 ± 0.079	1.969 MIN.	0.531 ± 0.039

SMA (DO-214AC)	SYMBOL	E	F	P	P0	P1	W	W1
	(mm)	1.75 ± 0.10	5.50 ± 0.05	4.00 ± 0.10	4.00 ± 0.10	2.00 ± 0.05	12.0 ± 0.30	18.4 (max)
	(inch)	0.689 ± 0.004	0.217 ± 0.002	0.157 ± 0.004	0.157 ± 0.004	0.079 ± 0.002	0.472 ± 0.012	0.724 (max)

Marking Code

Comchip logo

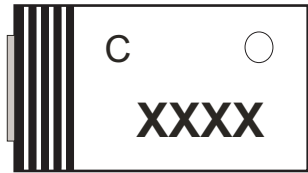

Package:

○	PKG
A	SMA
B	SMB
C	SMC

Product type marking code:

Part Number	Marking Code
CDBA120-G	B120
CDBA140-G	B140
CDBA160-G	B160
CDBA180-G	B180
CDBA1100-G	B1100

Suggested PAD Layout

SIZE	DO-214AC(SMA)	
	(mm)	(inch)
A	3.80	0.150
B	1.60	0.063
C	2.80	0.110
D	5.40	0.213
E	2.20	0.087

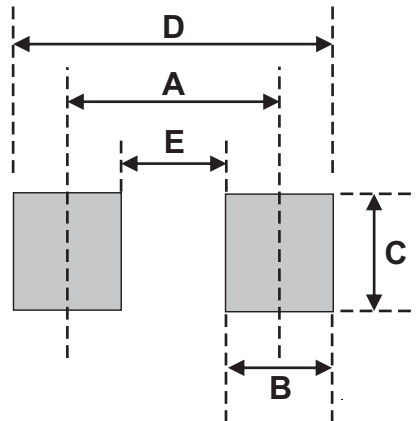

Standard Packaging

Case Type	REEL PACK	
	REEL (pcs)	Reel Size (inch)
DO-214AC (SMA)	5,000	13