

RF Power Field Effect Transistors

N-Channel Enhancement-Mode Lateral MOSFETs

Designed for CDMA base station applications with frequencies from 2110 to 2170 MHz. Suitable for CDMA and multicarrier amplifier applications. To be used in Class AB and Class C for PCN-PCS/cellular radio and WLL applications.

- Typical Single-Carrier W-CDMA Performance: $V_{DD} = 28$ Volts, $I_{DQ} = 1350$ mA, $P_{out} = 44$ Watts Avg., Full Frequency Band, IQ Magnitude Clipping, Channel Bandwidth = 3.84 MHz, Input Signal PAR = 7.5 dB @ 0.01% Probability on CCDF.
Power Gain — 17.5 dB
Drain Efficiency — 31%
Device Output Signal PAR — 6.1 dB @ 0.01% Probability on CCDF
ACPR @ 5 MHz Offset — -37 dBc in 3.84 MHz Channel Bandwidth
- Capable of Handling 5:1 VSWR, @ 32 Vdc, 2140 MHz, 150 Watts CW Output Power
- P_{out} @ 1 dB Compression Point ≥ 150 Watts CW

Features

- 100% PAR Tested for Guaranteed Output Power Capability
- Characterized with Series Equivalent Large-Signal Impedance Parameters
- Internally Matched for Ease of Use
- Integrated ESD Protection
- Greater Negative Gate-Source Voltage Range for Improved Class C Operation
- Designed for Digital Predistortion Error Correction Systems
- RoHS Compliant
- In Tape and Reel. R3 Suffix = 250 Units per 56 mm, 13 inch Reel.

MRF7S21150HR3
MRF7S21150HSR3

2110-2170 MHz, 44 W AVG., 28 V
SINGLE W-CDMA
LATERAL N-CHANNEL
RF POWER MOSFETs

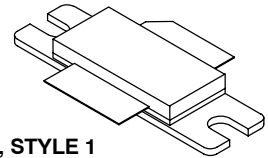

CASE 465-06, STYLE 1
NI-780
MRF7S21150HR3

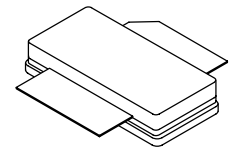

CASE 465A-06, STYLE 1
NI-780S
MRF7S21150HSR3

Table 1. Maximum Ratings

Rating	Symbol	Value	Unit
Drain-Source Voltage	V_{DSS}	-0.5, +65	Vdc
Gate-Source Voltage	V_{GS}	-6.0, +10	Vdc
Operating Voltage	V_{DD}	32, +0	Vdc
Storage Temperature Range	T_{stg}	-65 to +150	°C
Case Operating Temperature	T_C	150	°C
Operating Junction Temperature (1,2)	T_J	225	°C

Table 2. Thermal Characteristics

Characteristic	Symbol	Value (2,3)	Unit
Thermal Resistance, Junction to Case Case Temperature 80°C, 147 W CW Case Temperature 75°C, 45 W CW	$R_{\theta JC}$	0.33 0.37	°C/W

1. Continuous use at maximum temperature will affect MTTF.
2. MTTF calculator available at <http://www.freescale.com/rf>. Select Software & Tools/Development Tools/Calculators to access MTTF calculators by product.
3. Refer to AN1955, *Thermal Measurement Methodology of RF Power Amplifiers*. Go to <http://www.freescale.com/rf>. Select Documentation/Application Notes - AN1955.

Table 3. ESD Protection Characteristics

Test Methodology	Class
Human Body Model (per JESD22-A114)	1C (Minimum)
Machine Model (per EIA/JESD22-A115)	A (Minimum)
Charge Device Model (per JESD22-C101)	IV (Minimum)

Table 4. Electrical Characteristics ($T_C = 25^\circ\text{C}$ unless otherwise noted)

Characteristic	Symbol	Min	Typ	Max	Unit
Off Characteristics					
Zero Gate Voltage Drain Leakage Current ($V_{DS} = 65\text{ Vdc}$, $V_{GS} = 0\text{ Vdc}$)	I_{DSS}	—	—	10	μAdc
Zero Gate Voltage Drain Leakage Current ($V_{DS} = 28\text{ Vdc}$, $V_{GS} = 0\text{ Vdc}$)	I_{DSS}	—	—	1	μAdc
Gate-Source Leakage Current ($V_{GS} = 5\text{ Vdc}$, $V_{DS} = 0\text{ Vdc}$)	I_{GSS}	—	—	1	μAdc

On Characteristics

Gate Threshold Voltage ($V_{DS} = 10\text{ Vdc}$, $I_D = 348\ \mu\text{Adc}$)	$V_{GS(th)}$	1.2	2	2.7	Vdc
Gate Quiescent Voltage ($V_{DS} = 28\text{ Vdc}$, $I_D = 1350\text{ mAdc}$)	$V_{GS(Q)}$	—	2.7	—	Vdc
Fixture Gate Quiescent Voltage ⁽¹⁾ ($V_{DD} = 28\text{ Vdc}$, $I_D = 1350\text{ mAdc}$, Measured in Functional Test)	$V_{GG(Q)}$	4.5	5.4	6.5	Vdc
Drain-Source On-Voltage ($V_{GS} = 10\text{ Vdc}$, $I_D = 2.7\text{ Adc}$)	$V_{DS(on)}$	0.1	0.15	0.3	Vdc

Dynamic Characteristics ⁽²⁾

Reverse Transfer Capacitance ($V_{DS} = 28\text{ Vdc} \pm 30\text{ mV(rms)ac}$ @ 1 MHz, $V_{GS} = 0\text{ Vdc}$)	C_{rss}	—	0.9	—	pF
Output Capacitance ($V_{DS} = 28\text{ Vdc} \pm 30\text{ mV(rms)ac}$ @ 1 MHz, $V_{GS} = 0\text{ Vdc}$)	C_{oss}	—	590	—	pF
Input Capacitance ($V_{DS} = 28\text{ Vdc}$, $V_{GS} = 0\text{ Vdc} \pm 30\text{ mV(rms)ac}$ @ 1 MHz)	C_{iss}	—	320	—	pF

Functional Tests (In Freescale Test Fixture, 50 ohm system) $V_{DD} = 28\text{ Vdc}$, $I_{DQ} = 1350\text{ mA}$, $P_{out} = 44\text{ W Avg.}$, $f = 2112.5\text{ MHz}$ and $f = 2167.5\text{ MHz}$, Single-Carrier W-CDMA, IQ Magnitude Clipping, $PAR = 7.5\text{ dB}$ @ 0.01% Probability on CCDF. ACPR measured in 3.84 MHz Channel Bandwidth @ $\pm 5\text{ MHz}$ Offset.

Power Gain	G_{ps}	16.5	17.5	19.5	dB
Drain Efficiency	η_D	29	31	—	%
Output Peak-to-Average Ratio @ 0.01% Probability on CCDF	PAR	5.7	6.1	—	dB
Adjacent Channel Power Ratio	ACPR	—	-37	-35	dBc
Input Return Loss	IRL	—	-15	-9	dB

- $V_{GG} = 2 \times V_{GS(Q)}$. Parameter measured on Freescale Test Fixture, due to resistive divider network on the board. Refer to Test Circuit schematic.
- Part internally matched both on input and output.

(continued)

Table 4. Electrical Characteristics ($T_C = 25^\circ\text{C}$ unless otherwise noted) (continued)

Characteristic	Symbol	Min	Typ	Max	Unit
Typical Performances (In Freescale Test Fixture, 50 ohm system) $V_{DD} = 28 \text{ Vdc}$, $I_{DQ} = 1350 \text{ mA}$, 2110-2170 MHz Bandwidth					
Video Bandwidth @ 120 W PEP P_{out} where $IM3 = -30 \text{ dBc}$ (Tone Spacing from 100 kHz to VBW) $\Delta IMD3 = IMD3 @ \text{VBW frequency} - IMD3 @ 100 \text{ kHz} < 1 \text{ dBc}$ (both sidebands)	VBW	—	10	—	MHz
Gain Flatness in 60 MHz Bandwidth @ $P_{out} = 44 \text{ W Avg.}$	G_F	—	0.418	—	dB
Average Deviation from Linear Phase in 60 MHz Bandwidth @ $P_{out} = 150 \text{ W CW}$	Φ	—	36.5	—	°
Average Group Delay @ $P_{out} = 150 \text{ W CW}$, $f = 2140 \text{ MHz}$	Delay	—	2.82	—	ns
Part-to-Part Insertion Phase Variation @ $P_{out} = 150 \text{ W CW}$, $f = 2140 \text{ MHz}$, Six Sigma Window	$\Delta\Phi$	—	1.45	—	°
Gain Variation over Temperature (-30°C to $+85^\circ\text{C}$)	ΔG	—	0.013	—	dB/°C
Output Power Variation over Temperature (-30°C to $+85^\circ\text{C}$)	ΔP_{1dB}	—	0.007	—	dBm/°C

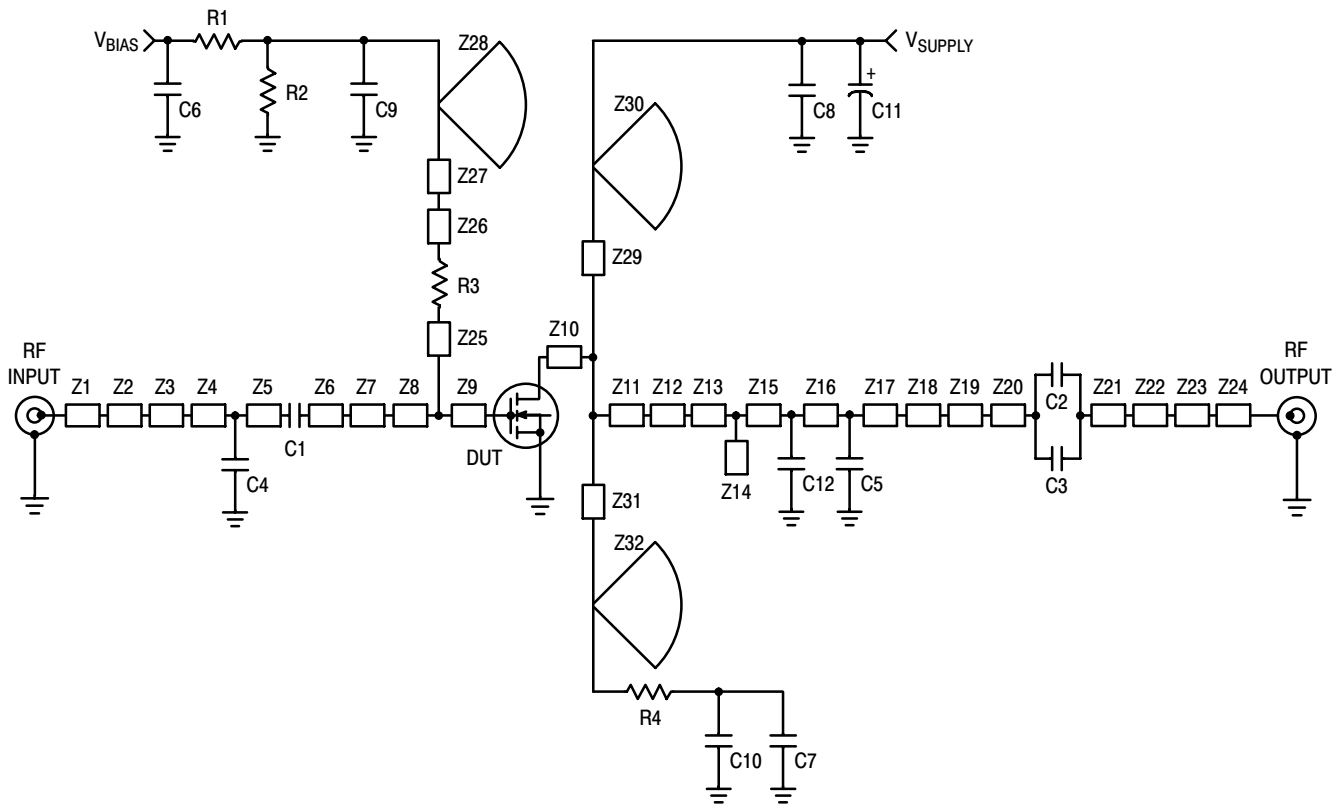

Z1	0.980" x 0.138" Microstrip	Z12	0.178" x 0.067" Microstrip	Z24	0.096" x 0.138" Microstrip
Z2	0.461" x 0.066" Microstrip	Z13	0.039" x 0.095" Microstrip	Z25	0.335" x 0.066" Microstrip
Z3	0.534" x 0.458" Microstrip	Z14	0.079" x 0.060" Microstrip	Z26	0.069" x 0.080" Microstrip
Z4*	0.138" x 0.126" Microstrip	Z15*	0.168" x 0.095" Microstrip	Z27	0.466" x 0.040" Microstrip
Z5*	0.536" x 0.126" Microstrip	Z16*	0.113" x 0.095" Microstrip	Z28	R = 0.526" $\alpha = 60^\circ$ Microstrip Butterfly
Z6	0.147" x 0.126" Microstrip	Z17*	0.128" x 0.095" Microstrip	Z29, Z31	0.825" x 0.066" Microstrip
Z7	0.060" x 0.513" Microstrip	Z18	0.079" x 0.215" Microstrip	Z30, Z32	R = 0.526" $\alpha = 60^\circ$ Microstrip Butterfly
Z8	0.151" x 0.630" Microstrip	Z19	0.020" x 0.095" Microstrip	PCB	Taconic TLX8-0300, 0.030", $\epsilon_r = 2.55$
Z9	0.112" x 0.630" Microstrip	Z20, Z21	0.070" x 0.215" Microstrip		
Z10	0.337" x 0.957" Microstrip	Z22	0.392" x 0.067" Microstrip		
Z11	0.176" x 0.957" Microstrip	Z23	0.370" x 0.089" Microstrip		

* Variable for tuning

Figure 1. MRF7S21150HR3(HSR3) Test Circuit Schematic

Table 5. MRF7S21150HR3(HSR3) Test Circuit Component Designations and Values

Part	Description	Part Number	Manufacturer
C1	0.7 pF Chip Capacitor	ATC100B0R7BT500XT	ATC
C2, C3	6.8 pF Chip Capacitors	ATC100B6R8BT500XT	ATC
C4, C12	0.2 pF Chip Capacitors	ATC100B0R2BT500XT	ATC
C5	0.3 pF Chip Capacitor	ATC100B0R3BT500XT	ATC
C6, C7, C8	10 μ F Chip Capacitors	C5750X5R1H106M	TDK
C9, C10	100 nF Chip Capacitors	C1206C104K2RAC	Kemet
C11	220 μ F, 63 V Electrolytic Capacitor, Axial	222212018221	Vishay BC Components
R1, R2	10 k Ω , 1/4 W Chip Resistors	CRCW12061002FKEA	Vishay
R3	10 Ω , 1/4 W Chip Resistor	CRCW120610R0FKEA	Vishay
R4	2.2 Ω , 1/4 W Chip Resistor	CRCW12062R20FKEA	Vishay

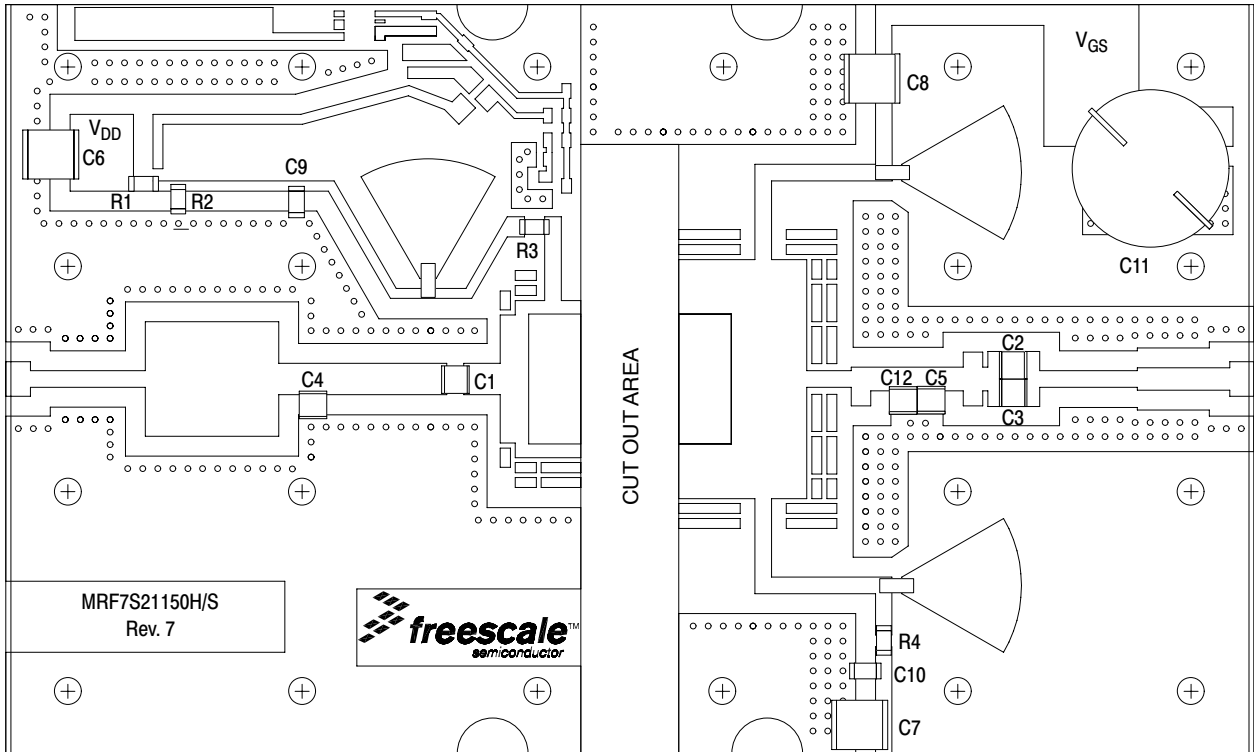

Figure 2. MRF7S21150HR3(HSR3) Test Circuit Component Layout

TYPICAL CHARACTERISTICS

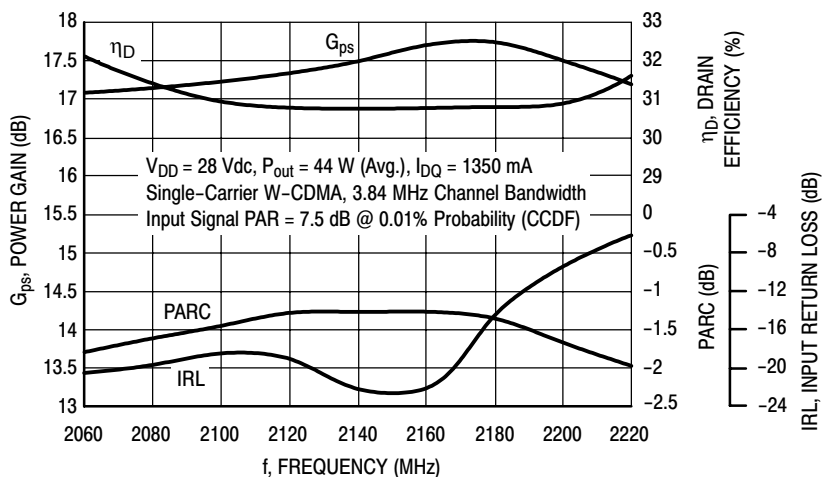

Figure 3. Output Peak-to-Average Ratio Compression (PARC) Broadband Performance @ $P_{out} = 44$ Watts Avg.

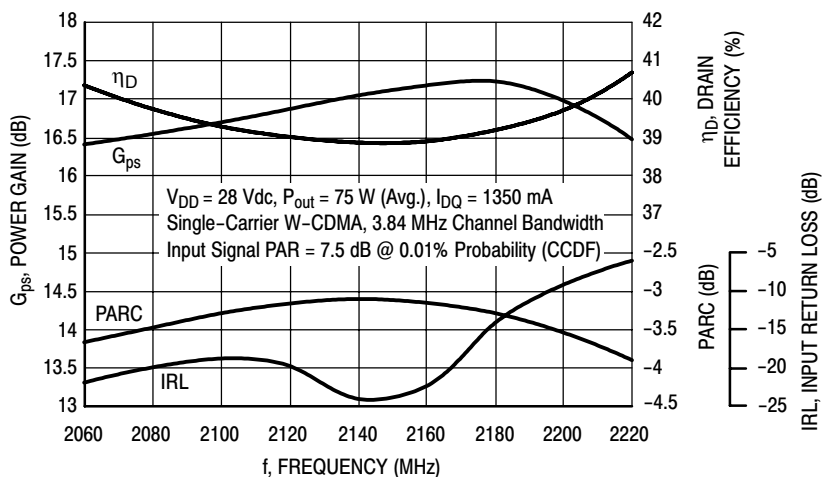

Figure 4. Output Peak-to-Average Ratio Compression (PARC) Broadband Performance @ $P_{out} = 75$ Watts Avg.

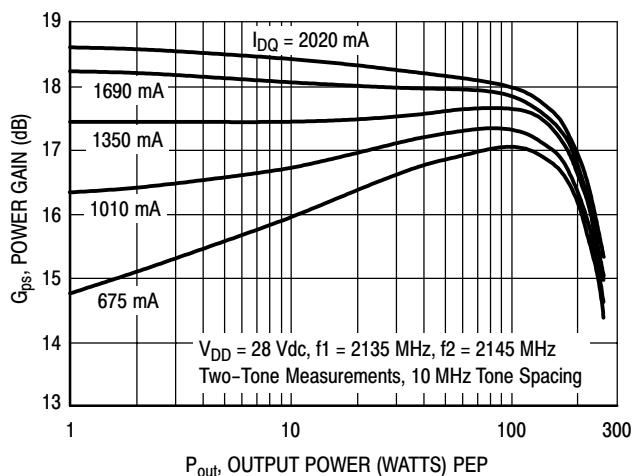

Figure 5. Two-Tone Power Gain versus Output Power

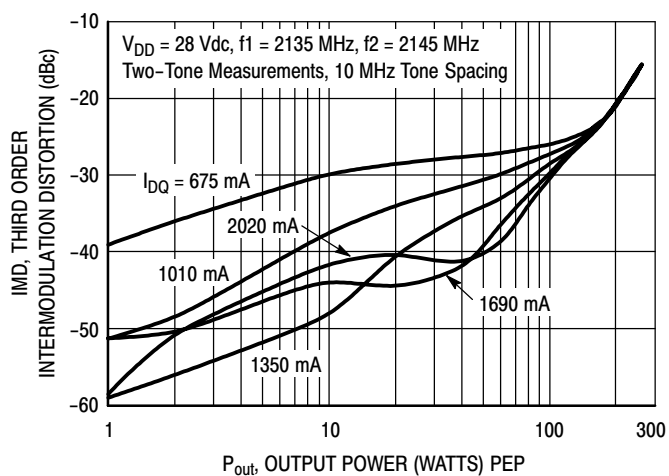

Figure 6. Third Order Intermodulation Distortion versus Output Power

TYPICAL CHARACTERISTICS

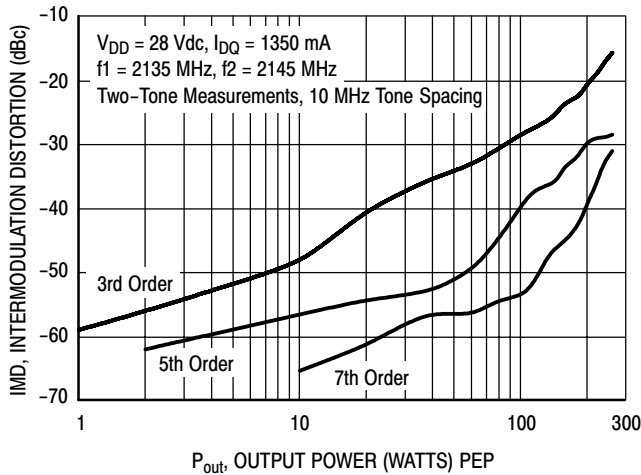

Figure 7. Intermodulation Distortion Products versus Output Power

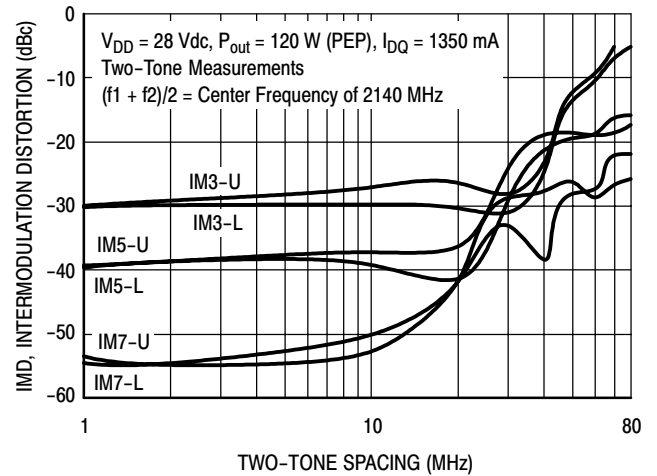

Figure 8. Intermodulation Distortion Products versus Tone Spacing

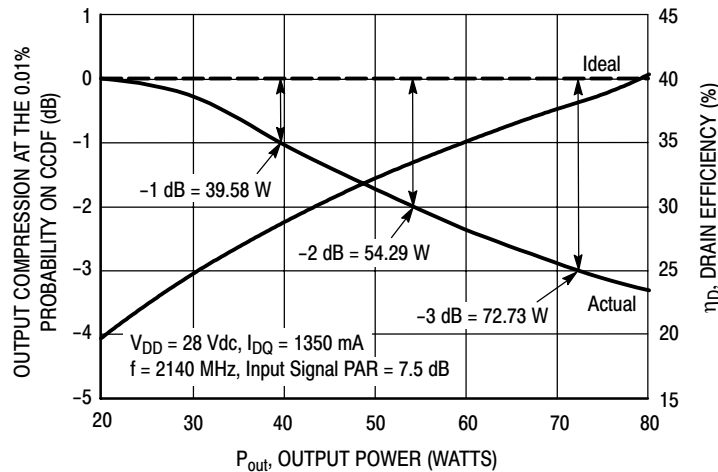

Figure 9. Output Peak-to-Average Ratio Compression (PARC) versus Output Power

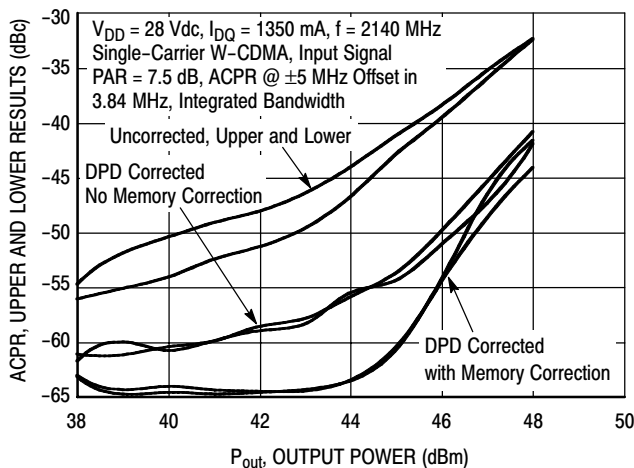

Figure 10. Digital Predistortion Correction versus ACPR and Output Power

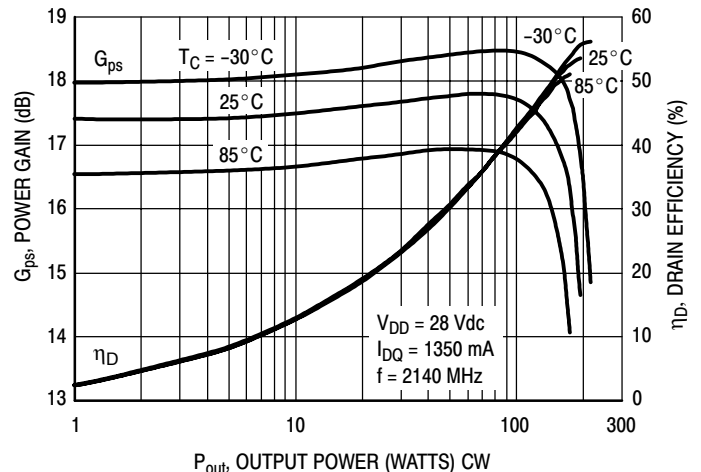

Figure 11. Power Gain and Drain Efficiency versus CW Output Power

MRF7S21150HR3 MRF7S21150HSR3

TYPICAL CHARACTERISTICS

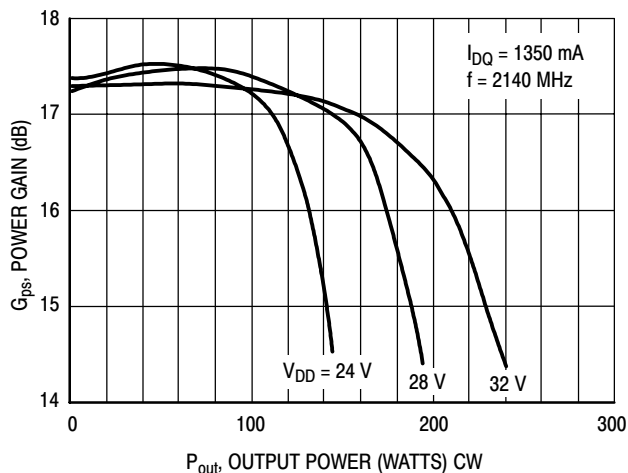
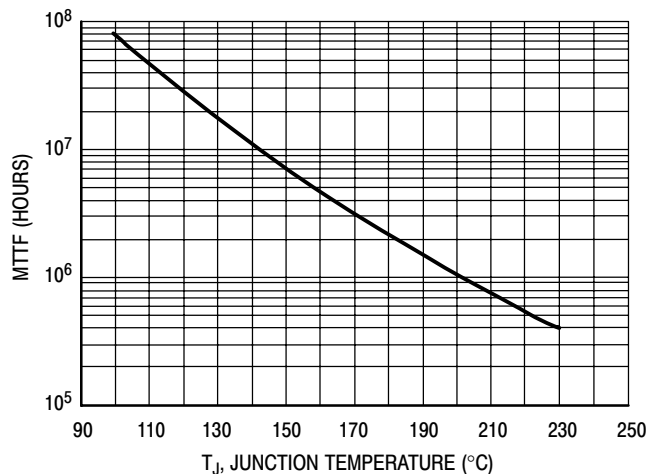

Figure 12. Power Gain versus Output Power



This above graph displays calculated MTTF in hours when the device is operated at $V_{DD} = 28$ Vdc, $P_{out} = 44$ W Avg., and $\eta_D = 31\%$.

MTTF calculator available at <http://www.freescale.com/rf>. Select Software & Tools/Development Tools/Calculators to access MTTF calculators by product.

Figure 13. MTTF versus Junction Temperature

W-CDMA TEST SIGNAL

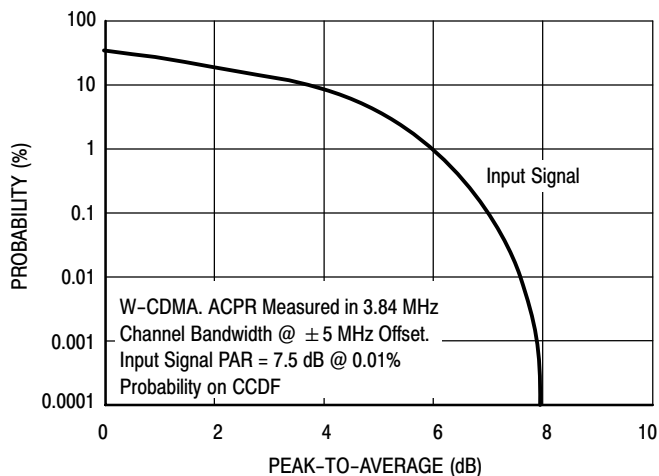

Figure 14. CCDF W-CDMA IQ Magnitude Clipping, Single-Carrier Test Signal

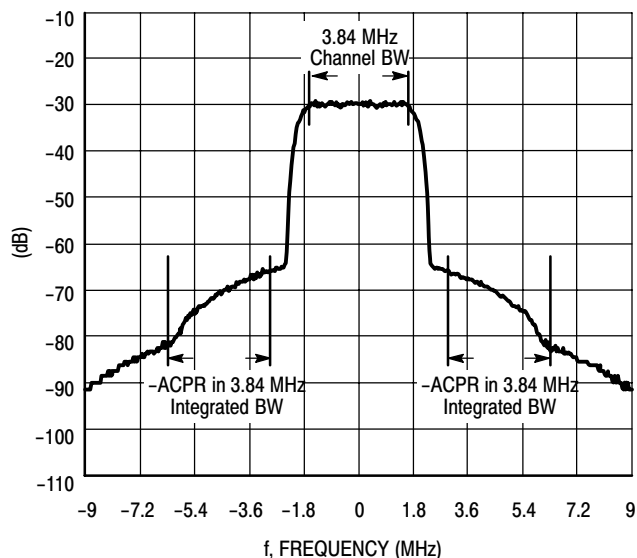
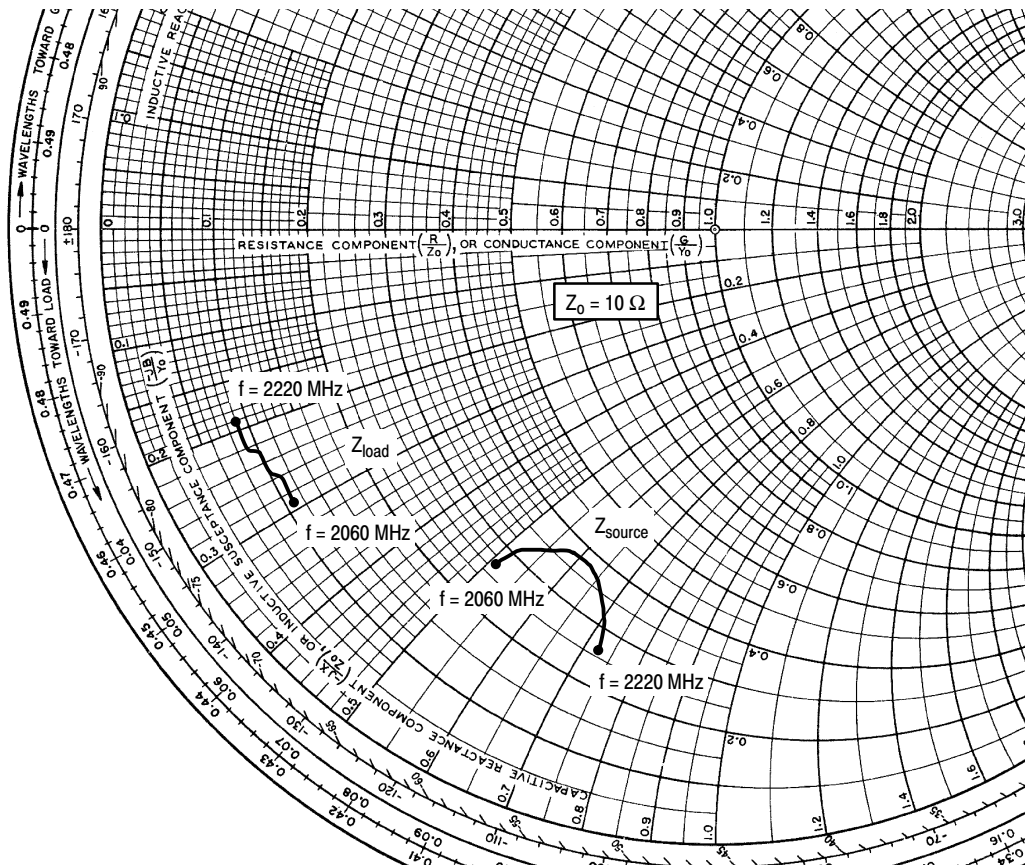

Figure 15. Single-Carrier W-CDMA Spectrum



$V_{DD} = 28 \text{ Vdc}$, $I_{DQ} = 1350 \text{ mA}$, $P_{out} = 44 \text{ W Avg.}$

f MHz	Z_{source} Ω	Z_{load} Ω
2060	2.72 - j5.08	1.14 - j2.89
2080	3.10 - j5.17	1.11 - j2.75
2100	3.43 - j5.39	1.08 - j2.62
2120	3.66 - j5.74	1.04 - j2.50
2140	3.72 - j6.17	1.00 - j2.39
2160	3.59 - j6.59	0.96 - j2.28
2180	3.33 - j6.91	0.93 - j2.17
2200	2.98 - j7.10	0.89 - j2.05
2220	2.62 - j7.17	0.86 - j1.93

Z_{source} = Test circuit impedance as measured from gate to ground.

Z_{load} = Test circuit impedance as measured from drain to ground.

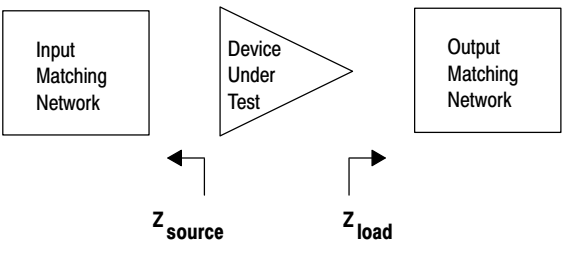
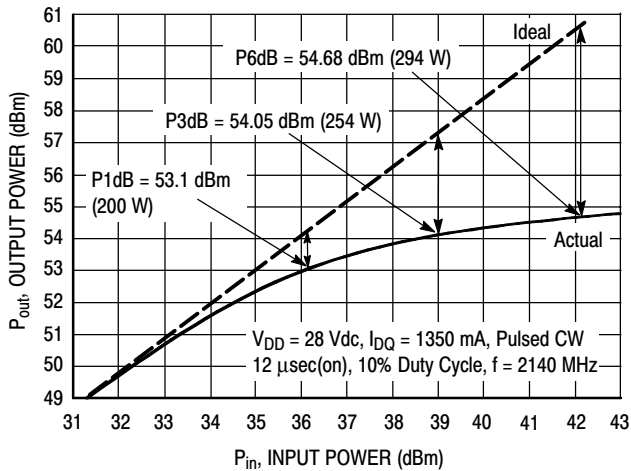

Figure 16. Series Equivalent Source and Load Impedance

ALTERNATIVE PEAK TUNE LOAD PULL CHARACTERISTICS



NOTE: Load Pull Test Fixture Tuned for Peak Output Power @ 28 V

Test Impedances per Compression Level

	Z_{source} Ω	Z_{load} Ω
P3dB	4.66 - j8.05	0.53 - j2.26

Figure 17. Pulsed CW Output Power versus Input Power @ 28 V

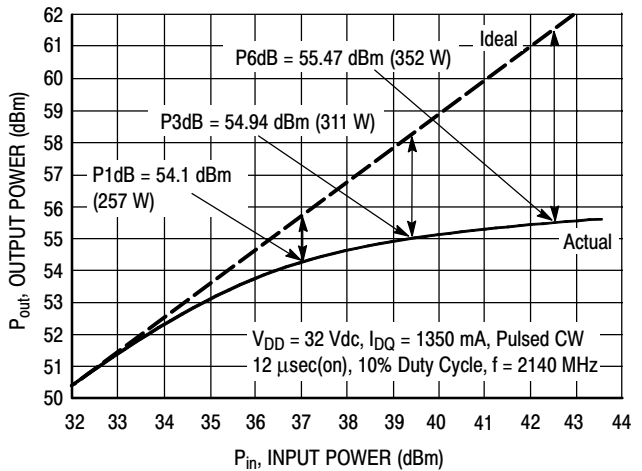

NOTE: Load Pull Test Fixture Tuned for Peak Output Power @ 32 V

Test Impedances per Compression Level

	Z_{source} Ω	Z_{load} Ω
P3dB	4.66 - j8.05	0.64 - j2.17

Figure 18. Pulsed CW Output Power versus Input Power @ 32 V

PACKAGE DIMENSIONS

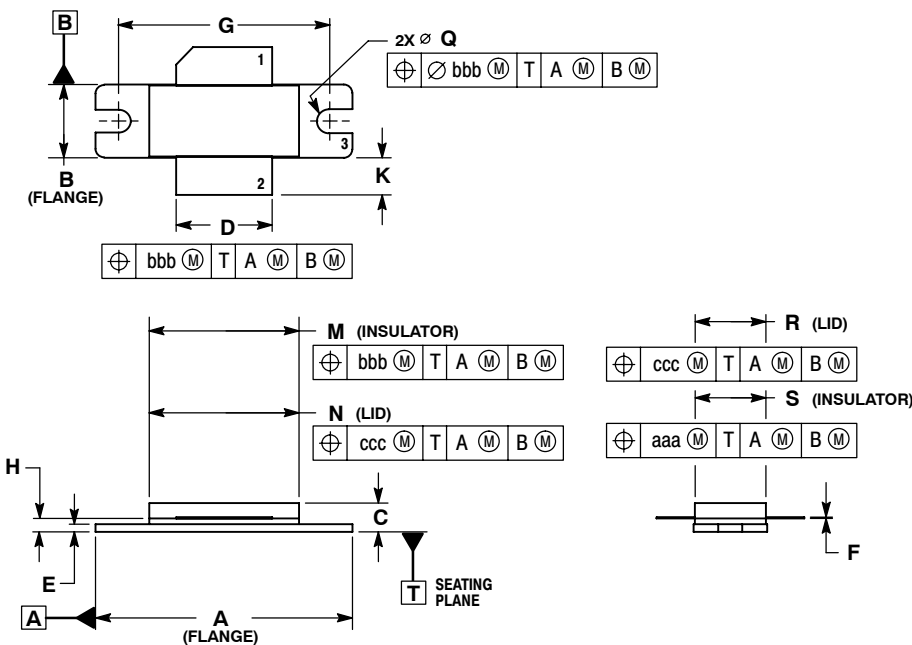

- NOTES:
1. DIMENSIONING AND TOLERANCING PER ANSI Y14.5M-1994.
 2. CONTROLLING DIMENSION: INCH.
 3. DELETED
 4. DIMENSION H IS MEASURED 0.030 (0.762) AWAY FROM PACKAGE BODY.

**CASE 465-06
ISSUE G
NI-780
MRF7S21150HR3**

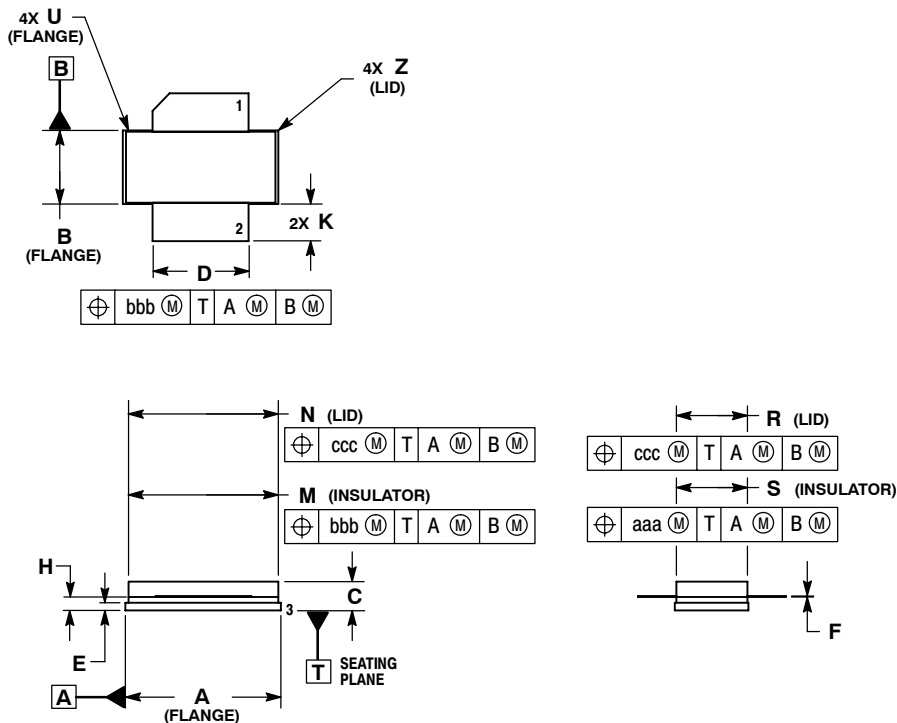

- NOTES:
1. DIMENSIONING AND TOLERANCING PER ANSI Y14.5M-1994.
 2. CONTROLLING DIMENSION: INCH.
 3. DELETED
 4. DIMENSION H IS MEASURED 0.030 (0.762) AWAY FROM PACKAGE BODY.

**CASE 465A-06
ISSUE H
NI-780S
MRF7S21150HSR3**

MRF7S21150HR3 MRF7S21150HSR3

PRODUCT DOCUMENTATION

Refer to the following documents to aid your design process.

Application Notes

- AN1955: Thermal Measurement Methodology of RF Power Amplifiers

Engineering Bulletins

- EB212: Using Data Sheet Impedances for RF LDMOS Devices

REVISION HISTORY

The following table summarizes revisions to this document.

Revision	Date	Description
0	Nov. 2007	<ul style="list-style-type: none">• Initial Release of Data Sheet
1	Apr. 2009	<ul style="list-style-type: none">• Corrected ESD structures to reflect current testing results. Changed HBM from 3A to 1C, p. 2• Updated Fig. 14, CCDF W-CDMA IQ Magnitude Clipping, Single-Carrier Test Signal, to better represent production test signal, p. 8

How to Reach Us:

Home Page:

www.freescale.com

Web Support:

<http://www.freescale.com/support>

USA/Europe or Locations Not Listed:

Freescale Semiconductor, Inc.
Technical Information Center, EL516
2100 East Elliot Road
Tempe, Arizona 85284
1-800-521-6274 or +1-480-768-2130
www.freescale.com/support

Europe, Middle East, and Africa:

Freescale Halbleiter Deutschland GmbH
Technical Information Center
Schatzbogen 7
81829 Muenchen, Germany
+44 1296 380 456 (English)
+46 8 52200080 (English)
+49 89 92103 559 (German)
+33 1 69 35 48 48 (French)
www.freescale.com/support

Japan:

Freescale Semiconductor Japan Ltd.
Headquarters
ARCO Tower 15F
1-8-1, Shimo-Meguro, Meguro-ku,
Tokyo 153-0064
Japan
0120 191014 or +81 3 5437 9125
support.japan@freescale.com

Asia/Pacific:

Freescale Semiconductor China Ltd.
Exchange Building 23F
No. 118 Jianguo Road
Chaoyang District
Beijing 100022
China
+86 10 5879 8000
support.asia@freescale.com

For Literature Requests Only:

Freescale Semiconductor Literature Distribution Center
1-800-441-2447 or +1-303-675-2140
Fax: +1-303-675-2150
LDCForFreescaleSemiconductor@hibbertgroup.com

Information in this document is provided solely to enable system and software implementers to use Freescale Semiconductor products. There are no express or implied copyright licenses granted hereunder to design or fabricate any integrated circuits or integrated circuits based on the information in this document.

Freescale Semiconductor reserves the right to make changes without further notice to any products herein. Freescale Semiconductor makes no warranty, representation or guarantee regarding the suitability of its products for any particular purpose, nor does Freescale Semiconductor assume any liability arising out of the application or use of any product or circuit, and specifically disclaims any and all liability, including without limitation consequential or incidental damages. "Typical" parameters that may be provided in Freescale Semiconductor data sheets and/or specifications can and do vary in different applications and actual performance may vary over time. All operating parameters, including "Typicals", must be validated for each customer application by customer's technical experts. Freescale Semiconductor does not convey any license under its patent rights nor the rights of others. Freescale Semiconductor products are not designed, intended, or authorized for use as components in systems intended for surgical implant into the body, or other applications intended to support or sustain life, or for any other application in which the failure of the Freescale Semiconductor product could create a situation where personal injury or death may occur. Should Buyer purchase or use Freescale Semiconductor products for any such unintended or unauthorized application, Buyer shall indemnify and hold Freescale Semiconductor and its officers, employees, subsidiaries, affiliates, and distributors harmless against all claims, costs, damages, and expenses, and reasonable attorney fees arising out of, directly or indirectly, any claim of personal injury or death associated with such unintended or unauthorized use, even if such claim alleges that Freescale Semiconductor was negligent regarding the design or manufacture of the part.

Freescale™ and the Freescale logo are trademarks of Freescale Semiconductor, Inc. All other product or service names are the property of their respective owners.

© Freescale Semiconductor, Inc. 2007, 2009. All rights reserved.

